

 **Kapema**  
*2021*

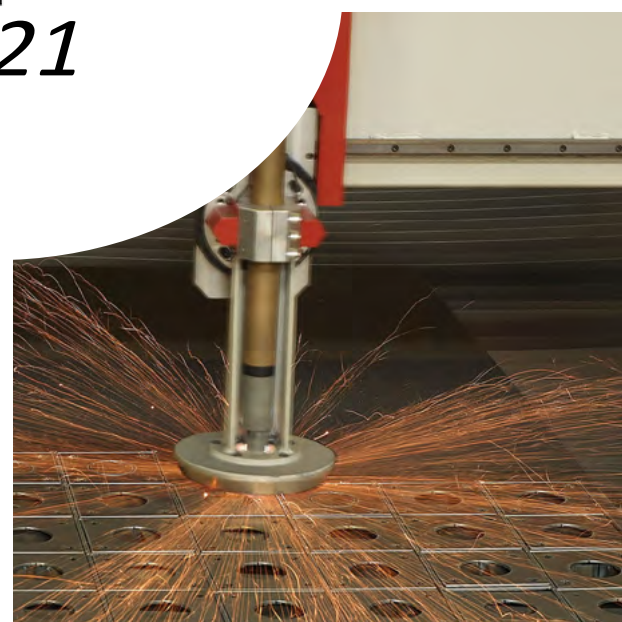



## - An international trading company



Kapema was founded in 2004 and is a competent and reliable supplier of machinery for sheet metal working. Besides buying and selling new and used equipment, we offer all kinds of services and automation of both new and existing machines.

The industry's widest range of products, including storekeeping of both machines and spare parts, as well as a unique service organization Kapema is an attractive partner within all areas of the sheet metal working industry.

Today we are one of the leading companies within sales and service of machinery for metallurgy. With a constant focus on

development, close relationships and innovation, we have been able to maintain a market leading position. Our exhibition facilities in Thisted are always open for demonstrations of any kind of machinery for sheet metal working as well as cutting.

We offer the market's most complete setup and deliver turnkey solutions such as:

- Uncovering the client's needs
- Supplying and installing machines
- Conducting machine courses
- Servicing the machine fleet



## Sheet Metal Working

Press brakes  
 Electrical press brakes  
 Shears  
 Plasma cutting machines  
 Waterjet cutting machines  
 Fiber lasers  
 Punching machines  
 Horizontal bending machines  
 Folding machines  
 Grinding and deburring machines  
 Coil processing  
 Hydraulic plate bending machines

**Baykal**

1-23

**EMC**

24-30

**TCI**

31-43

**Kimtech**

44-46

**Produtech**

47-48

**EKI Control**

49-52

**Erbend**

53-62

**Davi**

63-66

**CoastOne**

67-71

## Machining & cutting

Lathes  
 Milling machines  
 Machining centers

**Microcut**

72-113

**EMCO**

114-127

**First**

128-129

**Style**

130-135

**Jesco**

136-136

## Sawing

Band saws  
 Circular saws

**Meba**

137-140

**Imet**

141-167

## Pipe bending

Pipe bending machines  
 Pipe forming machines

**Transfluid**

168-177

**Jutec**

178-183

## Drilling machines

**Arboga**

184-190

# Hydraulic press brake type APH

Best  
Quality



NC control  
8822



NC control  
HT 072



NC control  
S 32

A solid welded construction ensures a minimum of deflection under load. Ram travel fully supported in low friction Pertinax slideways, which are easily adjustable. APH is equipped with patented hydro-mechanical system for exact parallelism and high repeatability. All machines are made with very solid torsionbar linkage for ram leveling.

Ram stroke control by precision mechanical stops built into each cylinder, and is electrically adjustable on a digital display, showing the position.

APH also has an independent position control of each cylinder, for precise angle adjustment and conical bending. APH is performed with high stroke and opening, which ensures the possibility of many different tools.

The machines are equipped with pressure switch and gauge to regulate bending tonnage easily, thereby avoiding overbending due to bottoming of tools. Hydraulic overload protection.

Preset two-speed bending cycle with "rapid traverse -> slow bending -> quick return." APH are standard with 3-function footswitch and compact hydraulics with minimum maintenance. The machines are supplied exclusively with European hydraulics and electrical components.



# Hydraulic press brake type APH

Best  
Quality

## Standard:

- Tool holder with wedge adjustment
- Standard tooling: Gooseneck top tools, and multi-vee bottom tools
- Front operated 1000mm ballscrew backgauge with digital read out control
- precision 0,1mm and 2 finger stops with micro-adjustable height
  - Digital stroke position display
  - Foot switch
  - Pendant control unit
- 2 laterally adjustable front support arms
- Hand screw clamps and chains to align and secure bottom die

## Optional:

- Programmable (NC) control for Y-stroke and X-backgauge
  - Special tooling
  - Top tools quick release clamps
  - Crowning tables ( Manual or motorised )
- Special control console for two-hand and foot pedal operation
  - Side and rear guarding
  - Backgauge longer than standard



Quick release clamps



Front support arms



Tool top / bottom

Art. no	Type	Cap.	Working length	Stroke	Daylight	Gap	Dist. btw. frames	Oil tank	Speed	Rapid traverse	Motor	Weight
		kN	mm	mm	mm	mm	mm	L	mm/s	mm/s	kw	kg
23200	APH 1254x40	400	1250	210	470	410	1070	80	10	100	4	3300
23202	APH 2103x40	400	2100	140	390	410	1600	140	10	90	4	3100
23204	APH 2604x60	600	2600	170	450	410	2050	140	9	90	5,5	5680
23206	APH 2606x90	900	2600	190	465	410	2050	140	10	80	7,5	6400
23208	APH 3104x90	900	3100	190	450	410	2550	140	10	95	7,5	6650
23210	APH 3106x120	1200	3100	210	475	410	2550	140	10	100	11	8050
23212	APH 3108x160	1600	3100	230	500	410	2550	210	8	90	11	8560
23214	APH 3110x200	2000	3100	250	535	410	2550	210	8	100	15	10500
23216	APH 3112x240	2400	3100	280	560	410	2550	210	8	85	18,5	12200
23218	APH 3116x300	3000	3100	300	595	500	2550	280	9	80	22	16000
23226	APH 4106x160	1600	4100	230	490	410	3550	210	8	90	11	12500
23228	APH 4108x200	2000	4100	250	500	410	3550	210	8	100	15	14500
23230	APH 4110x240	2400	4100	280	550	410	3550	210	8	100	18,5	15000
23232	APH 4112x300	3000	4100	300	580	500	3550	280	9	80	22	18500

# Hydraulic press brake type APHS Compact

Best  
Quality



APHS Compact 3110x200

Easy-to-use CNC system with complete bending computations and large tool library ideal for multi-bending of complex forms, as well as for volume production which require constant repeatability. Bend accuracy and repeatability at least five-fold higher than a conventional press brake. Fully synchronised Y1-Y2 axes to  $\pm 0.01\text{mm}$  via proportional valves and precision linear scales. Very fast AC servo backgauge system controlled by CNC. Euro-style top clamps with intermediaries and (available) quick-release clamping. Top tool is sectionalised gooseneck punch and bottom tool is sectionalised 4-V die. High stroke and daylight values. Extra deep (410 / 500 mm) throat gap. Two front arms on linear rail and dual footswitch console with emergency stop. Swiveling pendant arm and side / rear safety gates (electrically interlocked and/or light or laser guarded). Compactly-wired PLC electrics in ventilated cabinet. Type APHS Compact are constructed with rigidly welded, monoblock machine frame for minimum deflection under load. Ram travel fully supported in low friction slideways. Options for tooling and crowning.



Quick release Clamping



Motorised crowning

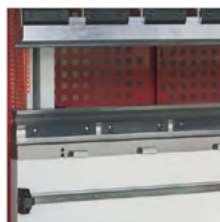

Tools



Manual crowning



Laser protection

# Hydraulic press brake type APHS Compact

Best  
Quality

## CNC operating features

- Controller type : Baykal EC4, 4-axes numerical CNC
- Controllable machine axes : Y1 - Y2 cylinder axes, 2 backgauge axes, Crowning axis
- Automatic identification of the best bend sequence numerically with collision detection
- 2D graphic editor for tool data entry
- Programming of the axis positions with automatic checks; automatic calculation of the R-axis position, bending tonnage and crowning
- High memory capacity for program steps and tooling data, capacity for 7000 programs and 80-steps in each program, high product number and 99 repeats of each program step
- FREE 2D graphical programming software to work off-line to create graphical bending files which can be transferred to the controller by USB flash disc

Product programming with direct angle input or in absolute dimensions. For each CNC program, the programmable and/or computed functions include : bending length/thickness, material selection, tooling selection, bend method, mute position, pinching point, press force/speed, incremental travel and retraction of backgauge, dwell time, delay time for axes repositioning, decompression speed, tilt adjustment, correction on Y and X axes.

- Manual operation of backgauge axes
- 16 selectable languages
- Memory storage on USB flash disk: information for tooling and programs

## Backgauge:

### (A) X-axes backgauge:

- Travel on ballscrew
- AC-servo driven
- With 2 micrometric finger-stops which have height and lateral adjustment
- Range : 1000 mm
- Speed : 330 mm/s
- Positioning precision :  $\pm 0.03$  mm



X-axis backgauge



X+R-axes backgauge

### (B) X-R axes backgauge:

- Travel on ballscrew
- AC-servo driven
- With 2 micrometric finger-stops which have lateral adjustment
- **Range**  
X-axis : 1000 mm  
R-axis : 160 mm
- **Travel speed (max)**  
X-axis : 350 mm/s  
R-axis : 240 mm/s
- **Positioning precision**  
X-axis :  $\pm 0.03$  mm  
R-axis :  $\pm 0.05$  mm



X-axis backgauge



X+R-axes backgauge

# Hydraulic press brake type APHS Compact

Best  
Quality



Motorised crowning



Support arms in front



EC4 CNC  
Offline programming



S 540  
2D Graphic CNC



ESA S550  
3D Windows



ESA S550-550  
2D Windows



ESA S540  
2D Windows

Art. no	Type	Cap.	Working length	Stroke	Daylight	Gap	Dist. btw. frames	Oil tank	Speed	Rapid traverse	Motor	Weight
		kN	mm	mm	mm	mm	mm	L	mm/s	mm/s	kw	kg
23300	APHS-C 1254x40	400	1250	215	455	410	1070	80	10	160	4	3300
23302	APHS-C 2104x60	600	2100	210	475	410	1600	140	10	150	5,5	5400
23304	APHS-C 2604x60	600	2600	210	475	410	2050	140	10	160	5,5	6200
23306	APHS-C 2606x90	900	2600	260	530	410	2050	140	10	150	7,5	7100
23308	APHS-C 3104x90	900	3100	260	530	410	2550	140	10	160	7,5	7900
23310	APHS-C 3106x120	1200	3100	260	530	410	2550	140	10	160	11	8400
23312	APHS-C 3108x160	1600	3100	260	530	410	2550	210	10	160	15	9700
23314	APHS-C 3110x200	2000	3100	260	530	410	2550	210	10	150	18,5	10000
23316	APHS-C 3112x240	2400	3100	260	530	410	2550	210	10	130	22	11000
23318	APHS-C 3116x300	3000	3100	320	660	500	2550	280	8	110	22	15000
23330	APHS-C 4106x160	1600	4100	260	530	410	3550	210	10	170	15	12000
23332	APHS-C 4108x200	2000	4100	260	530	410	3550	210	10	160	18,5	12500
23334	APHS-C 4110x240	2400	4100	260	530	410	3550	210	10	150	22	14000
23336	APHS-C 4112x300	3000	4100	320	635	500	3550	280	0	120	22	18500



# Hydraulic press brake type APHS

Best  
Quality



Rigidly welded, monoblock steel frame construction for minimum deflection under load. Downstroking bending beam with two cylinders made from high-quality forged steel and precisely honed for best precision. Ram travel fully supported in low friction fiber slideways and full electronic synchronisation with proportional valve technology assuring maximum bend accuracy and repeatability through constant monitoring and correction of beam parallelism by CNC system. Stroke-depth measurement through high-precision linear scales

CNC-controlled backgauge on ball screw spindles with DC drive. Block-type European hydraulics and compactly-wired electrical box with ventilation. Full conformity with EU Machinery Directive for safety and certified CE marking



# Hydraulic press brake type APHS

Best  
Quality

## (A) Backgauge system with X-axes:

- Travel on ballscrew spindles
- DC-motor driven
- Two micrometric stop-fingers with height and lateral adjustment
- Range : 1000 mm
- Travel speed (max) : 330 mm/s
- Positioning precision :  $\pm 0.03$  mm

## (B) Backgauge system with X-R axes:

- Travel on ballscrew spindles
- DC-motor driven
- Two micrometric stop-fingers with lateral adjustment
- Range:
  - X-axis : 1000 mm
  - R-axis : 160 mm
- Travel speed (max)
  - X-axis : 350 mm/s
  - R-axis : 240 mm/s
- Positioning precision
  - X-axis :  $\pm 0.03$  mm
  - R-axis :  $\pm 0.05$  mm

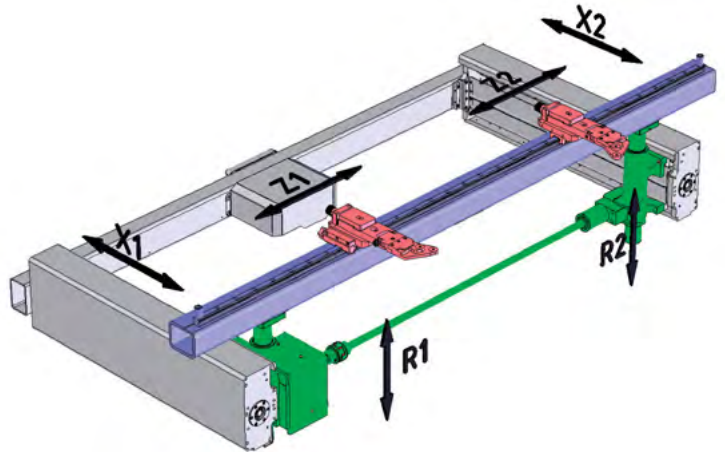

## (C) Backgauge system with X-R-Z1-Z2 axes:

- Travel on ballscrew spindles
- DC-motor driven
- Two micrometric stop-fingers with lateral adjustment
- Range
  - X-axis : 1000 mm
  - R-axis : 160 mm
  - Z-axis : Variable
- Travel speed (max)
  - X-axis : 350 mm/s
  - R-axis : 240 mm/s
  - Z-axis : 1000 mm/s
- Positioning precision
  - X-axis :  $\pm 0.03$  mm
  - R-axis :  $\pm 0.05$  mm
  - Z-axis :  $\pm 0.05$  mm



Examples of backgauges

## (D) Additional backgauge axes for special applications:

- X1 - X2
- R1 - R2
- Z1 - Z2

### Standard:

- European-style top tool holders with wedges
- Sectioned (gooseneck) punch and multi-vee die block (all tooling precisely ground)
  - Operation console with double foot-switch
    - Linear front-arm guides
- Electrically-interlocked side and rear guards

### Optional:

- Manual or power-driven (CNC) crowning tables
  - Top tool manual quick-release clamps
  - Hydraulic tool clamping systems
- Special tooling for customer applications:
  - Special-profile top and bottom tools
  - Single-vee dies with table adapters
- Front light guards or front laser protection for enhanced safety

### CNC unit

Graphical control with full programming and machine control facilities in a user-friendly computer environment. Main features include:

#### Programmable multi-axis control.

- Y1-Y2 cylinder axes
- X1-X2-R1-R2-Z1-Z2 backgauge axes
- CNC crowning axis
- Modular expansion for additional axes
- High memory capacity for program steps and tooling data
  - High number of product and bend repeat possibility
- Direct graphical programming with automatic computation of all axis positions and bend sequence in full graphic simulation
  - Manual operation of all axes
    - Teach-in on all axes
  - Operator selectable languages
  - Integrated diagnostic software
  - Memory storage on USB flashdisk

# Hydraulic press brake type APHS

Best  
Quality



Delem DA-56  
2D Windows



Delem DA-66T  
3D Windows



Delem DA-69T  
3D Windows



Cybelec DNC 880  
2D Windows

- VisiTouch 19, 2D graphic with 19" user-friendly HMI with intuitive programming, 3D visualisation and simulation of imported programs.
- VisiTouch 19 MX, full 3D programming, visualisation and simulation. Import of DXF, IGES, STEP and SAT-files. Automatic process with complex parts.

Art. no	Type	Cap.	Working length	Stroke	Daylight	Gap	Dist. btw. frames	Oil tank	Speed	Rapid traverse	Motor	Weight
		kN	mm	mm	mm	mm	mm	L	mm/s	mm/s	kw	kg
23450	APHS 1254x40	400	1250	215	455	410	1070	80	10	160	4	3300
23452	APHS 2104x60	600	2100	210	475	410	1600	140	10	150	5,5	5400
23454	APHS 2604x60	600	2600	210	475	410	2050	140	10	160	5,5	6200
23456	APHS 2606x90	900	2600	260	530	410	2050	140	10	150	7,5	7100
23458	APHS 3104x90	900	3100	260	530	410	2550	140	10	160	7,5	7900
23460	APHS 3106x120	1200	3100	260	530	410	2550	140	10	160	11	8400
23462	APHS 3108x160	1600	3100	260	530	410	2550	210	10	160	15	9700
23464	APHS 3110x200	2000	3100	260	530	410	2550	210	10	150	18,5	10000
23466	APHS 3112x240	2400	3100	260	530	410	2550	210	10	130	22	11000
23468	APHS 3116x300	3000	3100	320	660	500	2550	280	8	110	22	15000
23470	APHS 3120x440	4400	3100	320	575	500	2550	450	8	80	30	22000
23482	APHS 4106x160	1600	4100	260	530	410	3550	210	10	170	15	12000
23484	APHS 4108x200	2000	4100	260	530	410	3550	210	10	160	18,5	12500
23486	APHS 4110x240	2400	4100	260	530	410	3550	210	10	150	22	14000
23488	APHS 4112x300	3000	4100	320	635	500	3550	280	8	120	22	18500
23490	APHS 4116x440	4400	4100	320	590	500	3550	450	10	80	30	26000
23492	APHS 6104x160	1600	6100	260	510	500	5100	240	10	140	15	20000
23494	APHS 6106x240	2400	6100	260	5100	500	5100	300	8	140	22	25000
23496	APHS 6108x300	3000	6100	320	560	500	5100	300	8	120	22	30000
23498	APHS 6110x380	3800	6100	320	570	500	5100	450	8	90	30	35000

Bigger models are also available

# Hydraulic swing-beam shear type HGL

Best  
Quality



CybTouch 6

Hydraulic shear type HGL are constructed with a welded all steel frame providing maximum rigidity and cutting accuracy. Top beam and work table of box-type construction. HGL are equipped with rapid blade gap adjustment mechanism and swing-up backgauge system for cutting longer pieces than backgauge range. Backgauge is equipped with retract function. Type HGL is designed with a compact, low-maintenance hydraulic unit located underneath the work table. Hydraulic cylinders plainly designed and easily serviceable. Hydraulic holddown system and hydraulic overload protection. Fine-adjustment system for blades and adjustable stroke length to increase number of strokes on shorter cuts.

Standard:	Optional
<ul style="list-style-type: none"> <li>• Shear blades made from tough and wear-resistant alloyed material                             <ul style="list-style-type: none"> <li>- <i>Top blade: Two cutting edges</i></li> <li>- <i>Bottom blade: Four cutting edges</i></li> </ul> </li> <li>• 750 mm power backgauge with ballscrew spindles to 0.1mm precision                             <ul style="list-style-type: none"> <li>• Backgauge digital readout control                                     <ul style="list-style-type: none"> <li>• Digital stroke counter</li> </ul> </li> </ul> </li> <li>• Foot pedal control for single and repetitive cutting cycles</li> <li>• 1000 mm squaring arm with scale, T-slot and flip-stop                             <ul style="list-style-type: none"> <li>• Front support arms in 1000 mm length</li> </ul> </li> <li>• Work table with filler plates, ball transfers and hand slots                             <ul style="list-style-type: none"> <li>• Emergency stop buttons</li> </ul> </li> <li>• Shadow line facility with fluorescent lighting                             <ul style="list-style-type: none"> <li>• "See through" finger guard</li> </ul> </li> </ul>	<ul style="list-style-type: none"> <li>• Power blade gap adjustment with digital readout</li> <li>• Pneumatic rear support systems for thin sheets.                             <ul style="list-style-type: none"> <li>• Backgauge length other than standard</li> </ul> </li> <li>• T-slotted front support arms with scale and flip-stop</li> <li>• Squaring arm and front arm length other than standard                             <ul style="list-style-type: none"> <li>• Angle gauge</li> </ul> </li> <li>• 1000 mm lift-up front finger guard with electrically safety switch                             <ul style="list-style-type: none"> <li>• Holddown pads</li> <li>• Rear safety guarding</li> </ul> </li> </ul>

# Hydraulic swing-beam shear type HGL

Best  
Quality



Pneumatic  
sheetcatcher  
type A

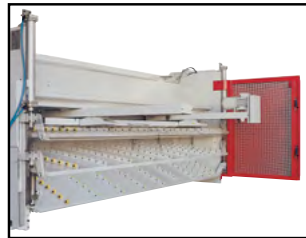

Pneumatic  
sheetcatcher  
type B

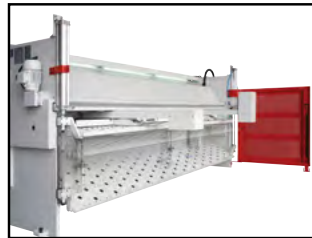

Pneumatic  
sheetcatcher  
type B with ball  
spindles



Pneumatic  
sheetcatcher  
type universal

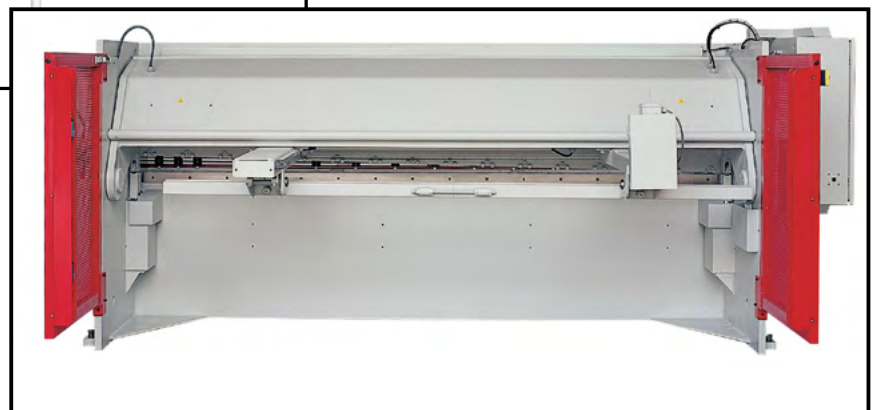

Art. no.	Type	Capacity	Cutting length	Cutting angle	Motor	Hold downs	Cuts	Oil tank	Back-gauge	Motor back-gauge	LxWxH	Weight
		mm	mm	°	kW	No.	pr/min	L	mm	kw	mm	kg
23001	HGL 2100x6	6	2060	1,6	11	13	26	160	750	0,37	2690x2400x1570	3850
23003	HGL 2100x8	8	2060	1,8	15	13	18	160	750	0,37	2735x2400x1570	4600
23000	HGL 2600x6	6	2560	1,6	11	15	24	160	750	0,37	3190x2400x1570	4700
23002	HGL 3100x6	6	3060	1,6	11	17	20	160	750	0,37	3690x2400x1570	5500
23004	HGL 3100x8	8	3060	1,8	15	17	13	160	750	0,37	3735x2400x1650	6450
23006	HGL 3700x6	6	3660	1,2	11	20	18	160	750	0,37	4395x2400x1650	7300
23008	HGL 4100x6	6	4060	1,2	11	23	12	160	750	0,37	4735x2400x1750	9400

# Hydraulic swing-beam shear type MGH

Best  
Quality



CybTouch 6

MGH is a solid welded construction, which gives very accurate cuts. The top beam moves with high precision, and rapid blade gap adjustment ensures high efficiency scissors. MGH is additionally equipped with swing-up backgauge to cut longer pieces than backgauge can handle. The backgauge is standard with “retract-function”. MGH is equipped with a compact, service friendly hydraulic unit under the table for easy access. MGH is equipped with hydraulic hold down system to sheets, hydraulic overload protection and fine adjustment of blades from lower beam. MGH is standard with 250mm side frame throat gap, allowing continuous strip slitting

## Standard:

- Shear blades made from tough and wear-resistant alloyed material
- Top blade: 2 cutting edges - bottom blade: 4 cutting edges
  - 1000mm power backgauge with ballscrew spindles to 0,1mm precision
  - Backgauge digital readout control
  - Digital cut counter
- Foot pedal control for single and repetitive cutting cycles
- 1000mm squaring arm with scale, t-stop and flip-stop
  - Front support arms in 1000mm
- Work table with filler plates, ball-transfer and hand slots
  - Emergency stop
  - Shadow line facility with fluorescent lighting
  - “See through” finger guard and side throat guards.

## Optional:

- Power blade gap adjustment with digital read out control
  - Pneumatic rear support systems for thin sheets
  - Backgauge longer than standard
- T-slotted front support arms with scale and flip-stop
- Squaring arm and front arm longer than standard
  - Worktime counter
  - Angle gauge
  - Holddown pads
- 1000mm lift-up front finger guard with electrically interlocked safety switch
  - Throat gap deeper than standard
  - Rear safety guarding

# Hydraulic swing-beam shear type MGH

Best  
Quality

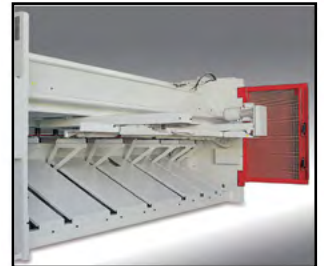
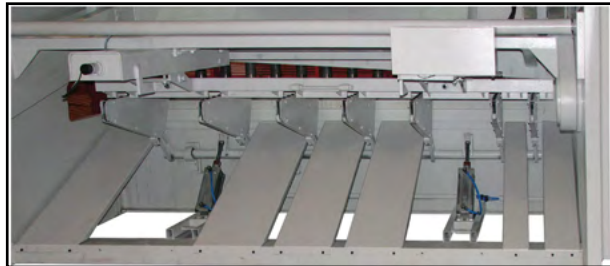

Pneumatic  
sheet catcher  
type D

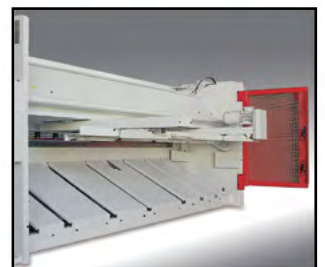

Pneumatic  
sheet catcher  
type A



Art. no	Type	Sheet thickness	Cutting length	Cutting angle	Motor	Hold-downs	Strokes	Oil tank	Back-gauge	Motor back-gauge	LXWXH	Weight
		mm	mm	°	kW	pcs	pr/min	L	mm	kw	mm	kg
23050	MGH 3100x6	6	3060	1,5	11	17	18	170	1000	0,37	3770x3100x1825	7000
23052	MGH 3100x10	10	3060	2,0	22	17	12	170	1000	0,37	3850x3275x1850	9200
23054	MGH 3100x13	13	3060	2,4	30	17	12	220	1000	0,37	3880x3485x2060	11500
23056	MGH 3100x16	16	3060	2,7	30	17	7	220	1000	0,37	3840x3550x2230	15500
23058	MGH 3100x20	20	3060	3,0	37	18	7	280	1000	0,37	3900x3540x2440	19600
23060	MGH 4100x10	10	4060	2,0	22	23	10	170	1000	0,37	4800x3375x1910	13000
23062	MGH 4100x13	13	4060	2,2	30	23	8	220	1000	0,37	4830x3375x2160	16100

# Hydraulic guillotine shear type HNC

Best  
Quality



Servo backgauge



Automatic swing-up for longer cuts

HNC 3100x20

Hydraulic shear type HNC is a rigidly welded all steel frame construction, which gives very accurate cuts, designed with a "Variable-rake" concept. Adjustment of machine functions are done with easy-to-use digital control units. The top beam moves with high precision, and rapid blade gap adjustment ensures high efficiency scissors. HNC is additionally equipped with swing-up backgauge to cut longer pieces than backgauge can handle. The backgauge is standard with "retract-function" and ballscrews. HNC is equipped with hydraulic hold down system to sheets, hydraulic overload protection and fine adjustment of blades from lower beam. MGH is standard with 350mm side frame throat gap, allowing continuous strip slitting. Adjustable stroke length to increase number of strokes on shorter cuts. Central manual lubrication system.

## Standard:

## Optional:

- Shear blades from tough and wear-resistant alloyed material:
  - Top blade : Two cutting edges*
  - Bottom blade : Four cutting edges*
- Digital control unit for backgauge positioning, rake adjustment, and blade gap setting
- Foot pedal control for single and repetitive cutting cycles
  - 1000 mm power backgauge with ballscrew spindles to 0.1 mm precision
  - 1000 mm squaring arm with scale, T-slot and flip-stop
    - Front support arms in 1000 mm length
      - Digital stroke counter
      - Pendant arm
  - Work table with filler plates, ball transfers and hand slots
  - Emergency stop buttons on the pendant and on the mainframe
  - Shadow line facility with fluorescent lighting • "See through"

- Multi-function electronic control units
  - Siemens OP7 S7-200
  - Cybelec DNC 60
- Servo driven backgauge movement
- Automatic "swing-up" backgauge mechanism for shearing longer pieces than maximum backgauge length
- Pneumatic rear support systems for thin sheets
  - Anti-twist system
- Front and rear sheet conveyor and stacking systems
  - Oil cooling or heating equipment
  - Throat gap deeper than standard
- Squaring arm and front arm length other than standard
  - T-slotted front support arms with scale and flip-stop
    - Angle gauge
- 1000 mm lift-up front finger guard with electrically safety switch
  - Holddown pads
  - Rear safety guarding



# Hydraulic guillotine shear type HNC

Best  
Quality

Made in  
EU

★★★



Cybelec DNC 60



Siemens OP7 S7-200



Art. no	Type	Sheet thickness	Cutting length	Cutting angle	Motor	Hold-downs	Strokes	Oil tank	Back-gauge	Motor back-gauge	LXWXH	Weight
		mm	mm	°	kW	antal	pr/min	L	mm	kw	mm	kg
23100	HNC 3100x6	6	3070	0,5-1,5	11	16	20-32	240	1000	0,37	3880x3190x2100	7800
23102	HNC 3100x10	10	3070	0,5-2,0	22	15	12-18	360	1000	0,37	3910x3300x2200	11000
23104	HNC 3100x13	13	3070	0,5-2,5	30	15	9-14	360	1000	0,37	3950x3385x2300	13000
23106	HNC 3100x16	16	3070	0,5-3,0	30	15	8-14	400	1000	0,55	3970x3380x2480	16500
23108	HNC 3100x20	20	3070	0,5-3,0	37	16	6-10	400	1000	0,55	4010x3620x2700	21000
23110	HNC 3100x25	25	3070	0,5-3,5	45	15	4-6	600	1000	0,55	3990x3605x3220	23000
23112	HNC 4100x6	6	4070	0,5-1,5	11	21	16-25	360	1000	0,55	4890x3450x2250	12000
23114	HNC 4100x10	10	4070	0,5-2,0	22	21	9-14	360	1000	0,55	4930x3380x2360	15000
23116	HNC 4100x13	13	4070	0,5-2,5	30	21	7-14	40	1000	0,55	4950x3645x2630	18000
23118	HNC 4100x16	16	4070	0,5-3,0	30	21	7-12	400	1000	0,55	4970x3630x2800	23500
23120	HNC 4100x20	20	4070	0,5-3,0	37	21	6-9	400	1000	0,55	5000x3630x2900	26000
23122	HNC 6100x6	6	6070	0,5-2,0	18,5	30	12-18	360	1000	0,55	6890x4130x2690	22000
23124	HNC 6100x10	10	6070	0,5-2,0	22	30	6-10	400	1000	0,55	6910x4125x2750	30000
23126	HNC 6100x13	13	6070	0,5-2,5	30	30	6-10	400	1000	0,75	6950x4200x3090	38000
23128	HNC 6100x16	16	6070	0,5-3,0	37	30	5-9	400	1000	0,75	6970x4420x3250	43000
23130	HNC 6100x20	20	6070	1,0-3,0	37	30	5-9	600	1000	0,75	6990x4280x3330	48000

# CNC plasma cutter type BPH Compact

Best  
Quality

Made in  
EU  
★★★



BPH compact 1503

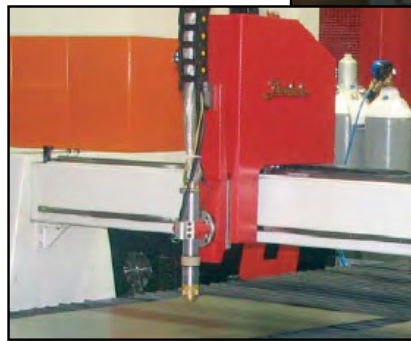
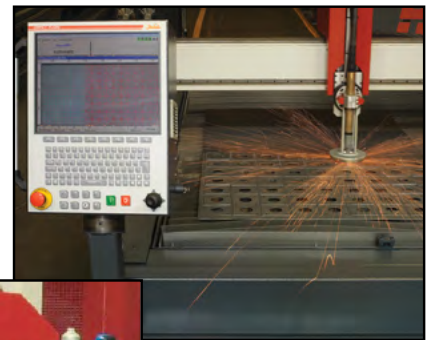

The tough little machine for ducting and light cutting. A high rail machine ideal for HVAC ducting work and other light sheet work but built with extra strength and precision so it can be upgraded to high definition plasma cutting for material up to 40 mm.

Simple operation - The Baykal compact is fitted with a very simple control so that new or occasional users can be trained in minutes. Type BPH are offered with a range of programming tools from Lantek, the most complicated sheet-metal developments of ducting components hoods etc. can be produced in seconds and downloaded to the machine for immediate cutting or combined.

BPH featuring a fully machined gantry and base with linear bearings on both longitudinal rails this machine is built to work hard and long. Because of its unitary design there is no need for a complicated installation and if necessary the machine can be readily moved around the workshop to suit changing workloads.

Type	Width	Length	Height	Table height	X-axis	Y-axis	Weight
	mm	mm	mm	mm	mm	mm	kg
BPH compact 1503	2140	4450	1750	750	3110	1600	2200

# CNC plasma cutter type BPS

Best Quality



BPS

This plasma cutter is the “flagship” in plasma cutting, when talking about quality and precision. Type BPS can be configured in a variety of solutions, of one or more oxygen-heads or with a combination of both plasma and oxygen-head. The table on the machines will be delivered to the specific task depending on the sheet thicknesses.

This machine are delivered with Hypertherm power sources, all of which can be supplied with their “true hole” technology. Therefore it will always be possible to achieve the maximum roundness at surfaces and precision, when cutting holes and smaller contours.

## True Hole Technology



Hypertherms patent-pending True Hole technology guarantees significantly better hole quality

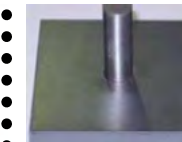

Without True Hole

With True Hole

# CNC plasma cutter type BPS

Best  
Quality

## Operating features:

- High precision plasma cutting technology
- High mechanical accuracy to:  $\pm 0.1$  mm
- Axis positioning speed: 30 m/min
- X and Y axis travel on precision linear rail guides
- Torch-height travel with ballscrews on dual linear guides
- Fast and accurate positioning with
- AC brushless servo motors:
  - Y-axis: dual synchronised servo drives
  - X-axis: single servo drive
- Cutting table independently constructed of bridge and machine frame to maintain positional accuracy under any table-load
- Patented crash protection on torch®
- Automatic torch height control
- Sectional cutting table with automatic fume extraction system
- Windows® based CNC unit
- Automatic nesting software
- Remote control option on large tables
- Optional dust and fume collector devices conforming to safety regulations
- Additional plasma or oxygen torch option



Type	Width	Length	Height	Table height	X axis	Y axis	Weight
	mm	mm	mm	mm	mm	mm	kg
BPS1503	3000	5200	1800	750	1700	3200	2800
BPS 2004	3500	6200	1800	750	2200	4200	3500
BPS 2006	3500	8200	1800	750	2200	6200	4100
BPS 2504	4000	6200	1800	750	2700	4200	4050
BPS 2506	4000	8200	1800	750	2700	6200	4750
BPS 3006	4500	8200	1800	750	3200	6200	5400
BPS 3009	4500	11200	1800	750	3200	9200	7100
BPS 3012	4500	14200	1800	750	3200	12200	8700
BPS 3014	4500	16200	1800	750	3200	14200	9500

# CNC plasma cutter type BPL-H

Best  
Quality



BPL-H

This plasma cutter is ideal for larger productions in plasma cutting, because it is possible to mount multiple plasma cutting heads combined with oxygen cutting heads. Up to 4 plasma cutting heads or up to 8 oxygen cutting heads. (Max 8 Cutting heads total)

Material thickness up to 300mm. and material length up to 60 meters.

This machine comes with Hypertherm power sources, all of which are available with their "true hole" technology - To achieve maximum roundness and precision in holes and minor contours.

Baykal also offers a "3D" plasma cutting head for cutting the surface area, i.e. to bevel cutting / sharpening of the workpieces.

Also available is a tube cut device with the machine.

As an option for this machine, are a "water table" so you can cool the materials and then cut under water, besides cooling, this also avoids smoke.



# CNC plasma cutter type BPL-H

Best  
Quality

## Design and operating features

- Availability of multi torch applications.
- Suitable for Oxy-fuel cutting up to 300 mm
- Best combination of Precision and very thick process machine.
- High precision plasma cutting technology
- High mechanical accuracy to:  $\pm 0.1$  mm
- Axis positioning speed: 30 m/min
- X and Y axis travel on precision linear rail guides
- Torch-height travel with ballscrews on dual linear guides
- Fast and accurate positioning with AC brushless servo motors:
  - Y-axis: dual synchronised servo drives
  - X-axis: single servo drive
- Cutting table independently constructed of bridge and machine frame to maintain positional accuracy under any table-load
- Patented crash protection on torch®
- Automatic torch height control
- Sectional cutting table with automatic fume extraction system
- Windows® based CNC unit
- Automatic nesting software
- Optional dust and fume collector devices conforming to safety regulations



Type	Width mm	Length mm	Height mm	Table height mm	X-axis mm	Y-axis mm	Weight kg
BPL-H 3006	5200	8000	1900	750	3200	6400	4100
BPL-H 3008	5200	10000	1900	750	3200	8400	5600
BPL-H 3010	5200	12000	1900	750	3200	10400	6300
BPL-H 3012	5200	14000	1900	750	3200	12400	7050
BPL-H 3014	5200	16000	1900	750	3200	14400	7800
BPL-H 3016	5200	18000	1900	750	3200	16400	9100
BPL-H 3018	5200	20000	1900	750	3200	18400	9850
BPL-H 4006	6200	8000	1900	750	4200	6400	5900
BPL-H 4008	6200	10000	1900	750	4200	8400	8200
BPL-H 4010	6200	12000	1900	750	4200	10400	9300
BPL-H 4012	6200	14000	1900	750	4200	12400	10450
BPL-H 4014	6200	16000	1900	750	4200	14400	11600
BPL-H 4016	6200	18000	1900	750	4200	16400	13700
BPL-H 4018	6200	20000	1900	750	4200	18400	14850

# Fiber laser type BLS-NEO

Best  
Quality

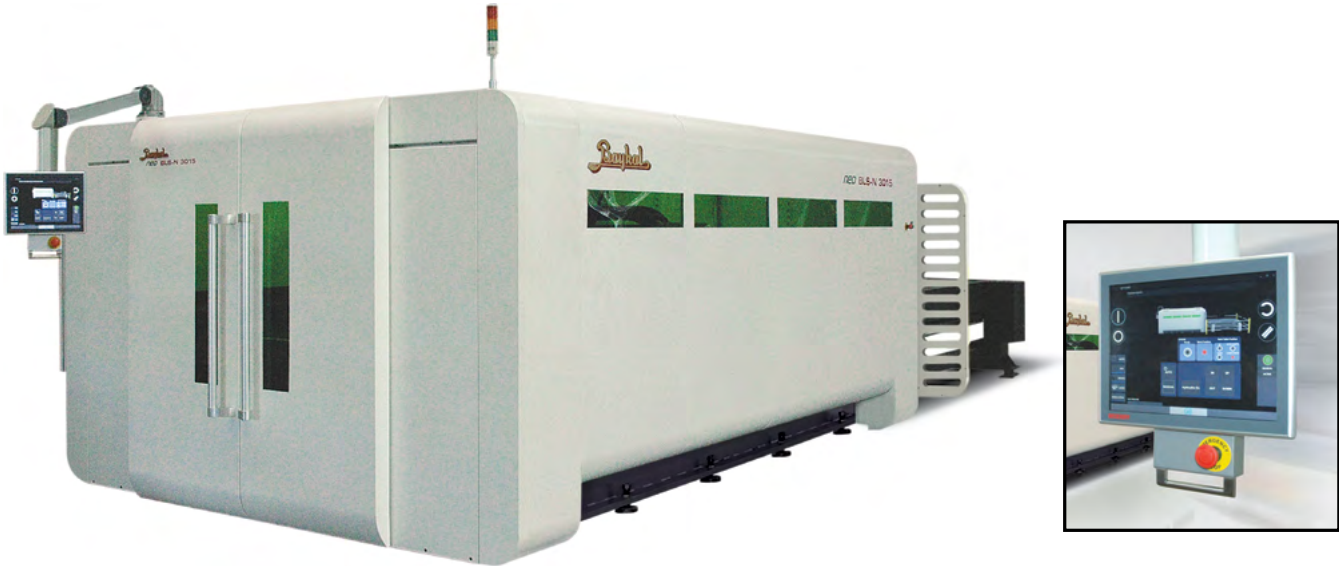

**BLS-NEO** fiber laser cutting machine uses two-dimensional drawings over the flat plate by moving the focused infrared light along the programmed pathways to cut. The system moves the laser light with fiber optic cable to the focuser cutting head, which moves on the fixed sheet metal. The cutting process occurs by melting the material in the area, where high-power laser light focused in very small diameters allows this to occur. Different gases are used to eject melted material from the surface of plate, according to type of materials. These gases exit from the nozzle, where the laser light exists and control the quality of process.

**BLS-NEO** fiber laser cutting offers the best solution to the user for cutting quality, precision, high cutting speed and low cost in cutting of fine material. It is possible to obtain these features at all high cutting speeds. BLS-NEO makes it possible to cut big or special size plates and offers competitive performances against similar fiber laser cutting machines in the industry.

- *Precise and ease of processing both large and small size formats.*
- *High speed and high precision servo motion system.*
- *No repositioning of plate ensures optimum accuracy.*
- *Fiber optic laser delivery system.*
- *Simple operator interface and cutting database.*
- *CNC controlled hydraulic lift-up dual shuttle table.*
- *Easy accessible remote diagnostic functions.*
- *Long lens life because of lens protection.*

## Benefits with BLS-NEO Fiber laser

- *low investment and operating costs.*
- *The most cost-efficient solution for every requirement.*
- *Very easy to operate.*
- *Quick and easy installation.*
- *Fast loading and unloading.*
- *Optional flexible shuttle table sizes.*
- *High-position control.*
- *Continuous cutting with moving shuttle table.*

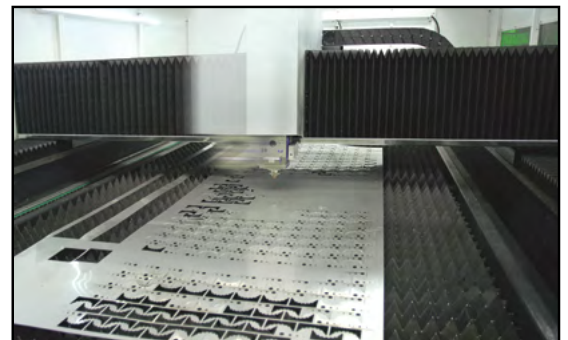

# Fiber laser type BLS-NEO

Best  
Quality

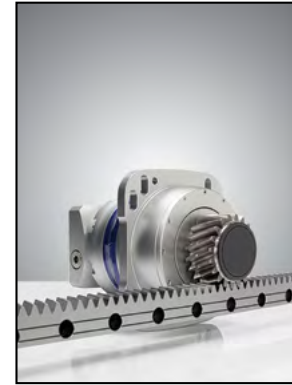

## Cost-efficient manufacturing:

BLS-NEO can be used with perfect precision that is provided by rack and pinion movement and also operate with a greater speed as compared to CO2 lasers. In addition, this laser technology offers low costs compared to a CO2 laser which is brought about by fiber technology.

## Maximum productivity – High acceleration:

BLS-NEO fiber laser cutting machine was designed as a bridge type, which is driven from both sides. Machine body, rigid and supply voltage are taken and offers high cutting accuracy and repeatability due to the very precision processed structure. Besides extraordinary robustness, it provides vibration-free cutting due to the supply rigidity, which was created by using innovative concepts and designed as one piece. High acceleration offers more precision while processing especially small diameter holes and sharp corners at high speeds.

## Automatic nozzle cleaning:

BLS-NEO carries out this process automatically according to the number of holes produced, which are determined by the CNC controlled nozzle cleaning and calibration feature. In this way, molten material that adheres to the nozzle end can be cleaned and thus cutting height of nozzle to the sheet plate can be kept constant. This directly affects the quality of cutting.

## User-friendly and reliable controller:

The multi-touch panel series from Beckhoff offers the greatest possible flexibility. The Beckhoff multi-touch panels with projective capacitive touch screen (PCT) technology feature a high touch-point density, which enables accurate, safe and jerk-free operation even in minute steps. The front of the display is a glass pane with an anti-reflection coating; operation with thin work gloves (e.g. latex gloves) is also possible. Five-finger touch and automation solutions with 2-hand operation are equally possible. Familiar functions from the world of smartphones and touchpads, such as zooming, scrolling, object turning, flicks etc. are now also usable for industrial applications with the multi-touch devices. Single-touch mode can be set via the windows operating system for applications where multi-touch is not required.

Type	Width	Length	Height	Cutting width	Cutting length
	mm	mm	mm	mm	mm
BLS-NEO 3015	6550	10500	2250	1500	3000
BLS-NEO 4020	7050	12500	2250	2000	4000
BLS-NEO 6020	7050	16500	2250	2000	6000
BLS-NEO 4030	8050	12500	2250	3000	4000
BLS-NEO 6030	8050	16500	2250	3000	6000
BLS-NEO 8030	8050	20500	2250	3000	8000

Capacity	Steel	Stainless	Alu	Copper	Brass
Power source	mm	mm	mm	mm	mm
1000 watt	12	4	3	2	1
2000 watt	15	8	6	3	3
3000 watt	18	10	8	4	4
4000 watt	20	12	10	6	4
6000 watt	25	15	15	8	8



# Fiber laser type BLE & BLE-PRO

Best  
Quality



The BLE fiber laser from Baykal is an all in one box design, suitable for customers who have a lack of space. This machine offers lower capital investment and lower operating costs, and it is a good solution for customers cutting in thin material up to 10 mm. This machine is easy to operate, reliable and precise, and has a unique cutting quality within the first minute of cutting process.

## Features for BLE:

- Precise and easy handling of both large and small items
- High speed and high precision through servo system
- Fiber optics laser system
- Simple and user-friendly operator interface and extensive cutting database
- Motorised transfer table
- Safety warnings and graphical diagnostic
- Low costs and low energy consumption
- Easy processing of copper, titanium and brass
- Low cooling capacity due to fiber optics
- Perfect beam quality and long lifetime for cutting lense
- Lantek nesting with maximum performance
- CAD 2D design
- CAD 3D design (optional)
- CNC control - movable

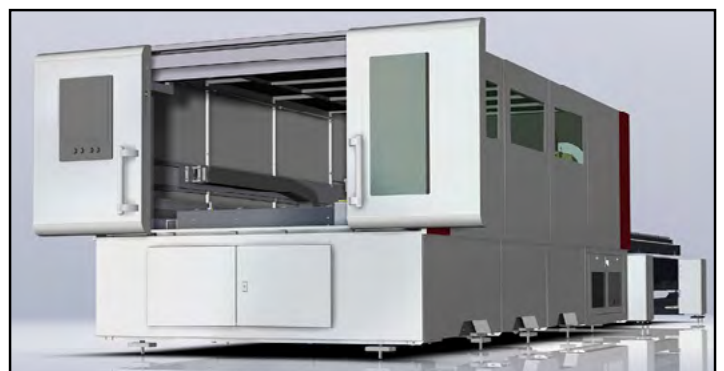

# Fiber laser type BLE & BLE-PRO

Best  
Quality

- BLE-PRO uses Precitec cutting head, which is one of the most commonly used brands in the industry.
- Distance to the workpiece remains the same via a capacitive sensor.
- Laser head is easy interchangeable.
- Anti-collision system on the laser head, so that the laser will stop immediately if the cutting head should collide with the workpiece.
- Via the CNC control you can program an automatic nozzle cleaning and a calibration of the nozzle.
- Parts debris conveyor for small parts, scraps and slag from cutting table (option).
- Autofocus - Proven Lasermatic® distance sensor.
- IPG and Nlight resonator according to requirements.

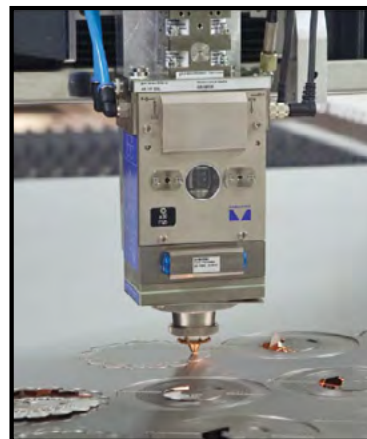

		BLE 1530	BLE -PRO 1530
Laser power	W	1000, 1200, 1500, 2000	1000, 1500, 2000, 2500, 3000, 4000
Workpiece dimensions	mm	1524 x 3048	
X-axis (rack & pinion)	mm	3000	
Y-axis (rack & pinion)	mm	1500	
Z-axis (ball screw)	mm	150	
Rapid traverse (X-Y axes)	m/min.	90	110
Vector speed	m/min.	125	145
Acceleration		1 G	1,2 G
Positioning accuracy	mm	± 0,08	
Repeatability	mm	± 0,03	
Feed rate	m/min.	up to 50 m/min. depending on material and thickness	
Focusing lenses		150 mm	
Transfer table		motorised - automatic	
Max. load capacity	kg	1000 pr. bord	
Max. cutting capacity (depending on laser strength)	mm	0-20 (stål) 0-10 (rustfri) 0-8 (aluminium)	
CNC control		Baykal CNC 19" TFT-Windows 7	Beckhoff CNC 19" TFT-Windows 7
Nesting software		LANTEK Expert Cut Sharp	LANTEK Expert Cut
Automatic nozzle cleaning and calibration		Standard	

# EMC grinding & deburring OXY M650

Best  
Quality

Made in  
EU  
★ ★ ★

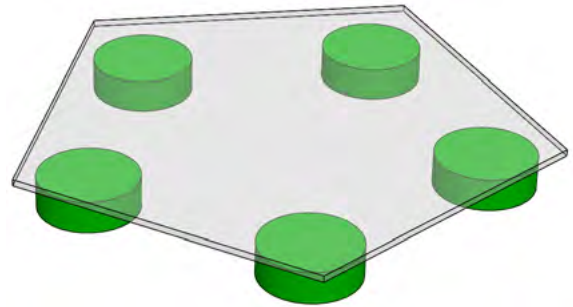

EMC grinding and deburring machine type OXY M650 is a compact and versatile machine initially designed for the calamine removal, but thanks to the quick release tools, in a few minutes it can also be used for deburring or edge rounding simply by changing the type of tool. OXY M650 can process both steel, stainless steel, aluminium and other advanced materials, and is especially suited for deburring of items from laser processing.

The design is smart and compact, small size easy to place and easy to operate and with high processing speeds.

Its working width of 650 mm and the fixed table of 900 mm make it compact and ideal for any type of company in the sector.

## Basic machine:

- Orbital working system by 1 group
- Fixed work table 900 mm
- Vacuum table with inverter
- Inverter for carousel
- Inverter for feed belt
- Quick easy discs changing device
- Z-axis up and down adjustment automatically controlled via digital display

Tangential brushes with quick change device

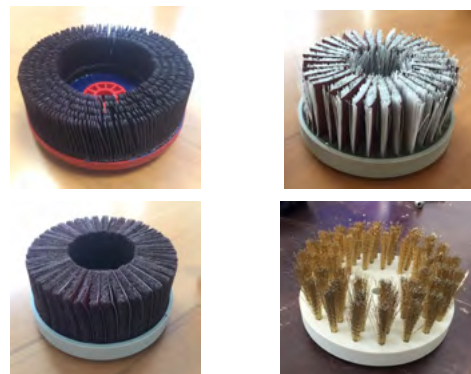

Type	Work width	Work thickness	Capacity	Cutting speed	Ø Aspiration	Motor	L x W x H	Weight
	mm	min-max mm	mm <sup>3</sup> /h (25)	RPM	mm		mm	kg
OXY M650	650	0,5:150	990	800	120	3 kW	1400x1500x1100	1000

# EMC grinding & deburring EASY M1100

Best  
Quality



EMC grinding and deburring machine type EASY M1100 is a compact and versatile machine initially designed for the calamine removal, but thanks to the quick release tools, in a few minutes it can also be used for deburring or edge rounding simply by changing the type of tool. EASY M1100 can process both steel, stainless steel, aluminium and other advanced materials, and is especially suited for deburring of items from laser processing.

The design is smart and compact, and ideal for any type of company in the sector. EASY is to be connected to a dust extraction system.

## Standard:

- Welded cage type frame, made in carbon steel
- Single Motor power for 1° and 2° unit: 15Kw (20hp) + INVERTER
- Oscillation adjustment control on stroke and time
- Rubber covered presser rollers, grooved, oil corrosion and heat resistant to 120°
- Motorized table lifting including fine adjustment, made on 4 precision screws
- Special rubber flat feed belt 2 nets, water, corrosion, oil and heat resistant to 120°
- Automatic feed belt centring device
- Automatic lifting of groups in case of emergencies
- Electronic digital display for working thickness; resolution 0,1 mm
- Check control panel; self-diagnostics alarm control unit
- Analogic amperimeters, for each motor, on main control cabinet
- Main control cabinet centralized and IP54 protection
- Centralized independent pneumatic control cabinet, protection; dust proof
- Pneumatic plant working without lubrication
- Compressed air pressure 6 bar
- Automatic emergency stops and alarm display

Type	Working width	Thickness	Capacity	Belt speed	Belt dim. LxW	Motor	L x W x H
	mm	min-max mm	mm <sup>3</sup> /h (25)	m./min.	mm	kW	mm
EASY M1100	1100	0,5:150	2000	1-10	1900x1120	15	1450x1225x1920

# EMC grinding & deburring FLEXY M1350

Best  
Quality

Made in  
EU  
★★★

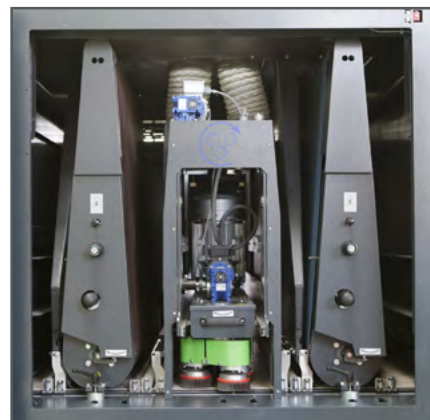

Roller unit Ø250 / Tangential brushes system / planetary system / Electronic grit set

EMC grinding and deburring machine type FLEXY M1350 is a compact and versatile machine, ideal for satin, grinding, deburring, edge rounding and removal of calamine on any type of material. The high dynamism makes it flexible and reliable over time.

Its working width of 1350 mm and the fixed table of 900 mm allow it to work in line with other machines or stand alone.

This machine can be used for both dry and wet processes.

## Basic machine:

- Version with 2/3 groups
- Fixed work table 900 mm
- Internal independent motors
- Inverter for feed standard
- Electronic motorised roller pressure adjustment "grit set"
- Touch screen 10"
- Teleservice

Tangential brushes with quick change device

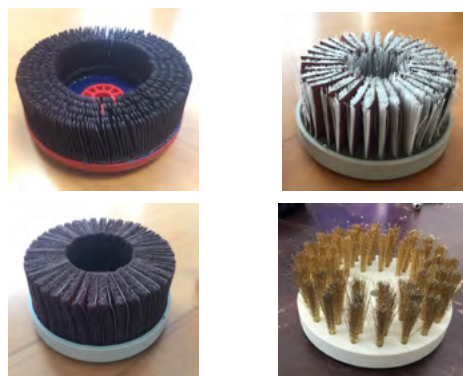

Type	Units	Work width	Work thickness	Capacity	Ø Aspiration	L x W x H	Weight
		mm	min-max mm	mm <sup>3</sup> /h (25)	mm	mm	kg
FLEXY M1350	2	1350	0,5:160	5660	200	2060x2165x2200	2600
FLEXY M1350	3	1350	0,5:160	8490	200	2060x2625x2200	3200

# EMC grinding & deburring FLEXY M1350

Best Quality

## Options:

- Internal brushes group
- Internal orbital discs group
- Internal planetary discs group
- Magnetic work table
- Vacuum fan inside the machine
- Industry 4.0 ready pack
- Brush for panels cleaning
- Brush for feed belt cleaning
- Double external brush unit
- Magnet band
- Roller table extension
- Quality control special lights
- Compacts belt blowers
- Turbo rotating blowers
- Machine version left or right
- Automatic positioner
- Custom machine with remote control, statistics display and virtual assistance



Internal vacuum fan  
(setting variable inverter)



Planetary unit

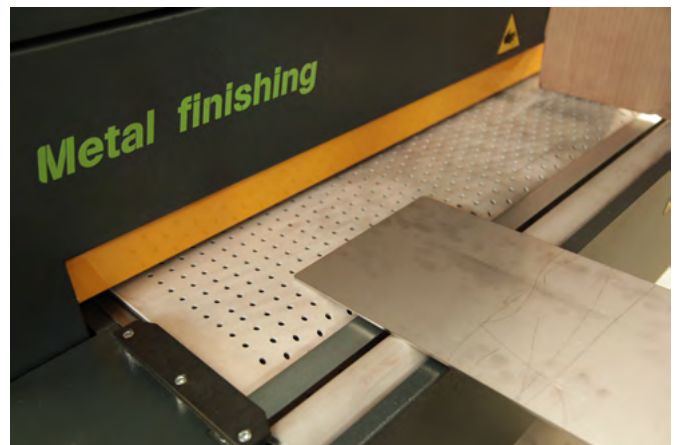

	1°/ 2°/ 3° group	2°/ 3° group	2°/ 3° group	2°/ 3° group	2°/ 3° group
	Roller group (R)	Brush group internal (B)	Disc group internal (h)	Disc group internal (H)	Planetary group internal (Q)
Dimension	2620/1370 (Ø250)	Ø250	6 x Ø200	12 x Ø160	15 x Ø120
Power max.	11 kW	3 kW	5,5 kW	7,5 kW	11 kW
Cutting speed	18 m/s	16 m/s	14 m/s	14 m/s	13 m/s

# EMC grinding & deburring GIANT M1350 - 1650

Best  
Quality



Flexibility of configuration

EMC grinding and deburring machine type GIANT M1350 - 1650 is the largest in the category of EMC grinding/deburring machines. Thanks to its structure it can be equipped with 2 to 4 units (or more). It is ideal for satin, grinding, deburring, edge rounding and removal of calamine on any type of material. The high dynamism makes it flexible and reliable over time.

Its working width can be 1350 or 1650 mm (or more). Thanks to the fixed table of 900 mm it can be placed in line with other machines or work standing alone.

This machine can be used for both dry and wet processes.

## Basic machine:

- Version with 2/3/4 groups
- Fixed work table 900 mm
- Internal independent motors
- Inverter for feed standard
- Electronic motorised roller pressure adjustment "grit set"
- Touch screen 10"
- Teleservice

Tangential brushes with quick change device



Type	Units	Work width	Work thickness	Capacity	Ø Aspiration	L x W x H	Weight
		mm	min-max mm	mm <sup>3</sup> /h (25)	mm	mm	kg
GIANT M1350-1650	2	1350	0,5:160	5660	200	2174x4180x2571	3000
GIANT M1350-1650	3	1350	0,5:160	8490	200	2174x4640x2571	3600
GIANT M1350-1650	4	1350	0,5:160	11320	200	2174x5100x2571	4200

# EMC grinding & deburring GIANT M1350 - 1650

Best  
Quality

## Options:

- Internal brushes group
- Internal orbital discs group
- Internal planetary discs group
- Magnetic work table
- Vacuum fan inside the machine
- Industry 4.0 ready pack
- Brush for panels cleaning
- Brush for feed belt cleaning
- Double external brush unit
- Magnet band
- Roller table extension
- Quality control special lights
- Compacts belt blowers
- Turbo rotating blowers
- Machine version left or right
- Automatic positioner
- Custom machine with remote control, statistics display and virtual assistance

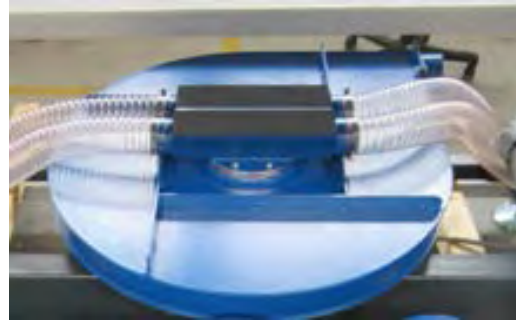

Internal vacuum fan  
(setting variable inverter)



	1°/ 2°/ 3° group	2°/ 3° group	2°/ 3° group	2°/ 3° group	2°/ 3° group
	Roller group (R)	Brush group internal (B)	Disc group internal (h)	Disc group internal (H)	Planetary group internal (Q)
Dimension	2620/1370 (Ø250)	Ø250	6 x Ø200	12 x Ø160	15 x Ø120
Power max.	11 kW	3 kW	3 kW	7,5 kW	11 kW
Cutting speed	18 m/s	16 m/s	10 m/s	14 m/s	13 m/s



# EMC grinding & deburring machines

Best  
Quality

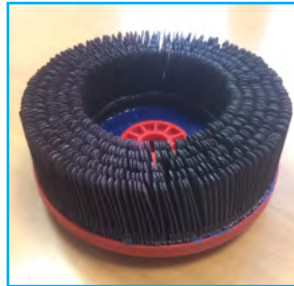
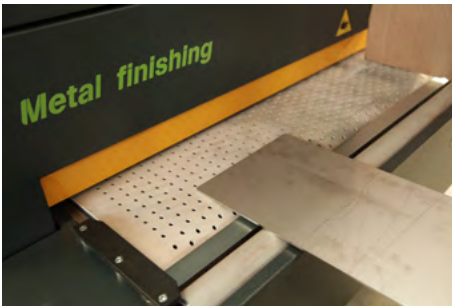

Abrasive



Scotch brite + abrasive

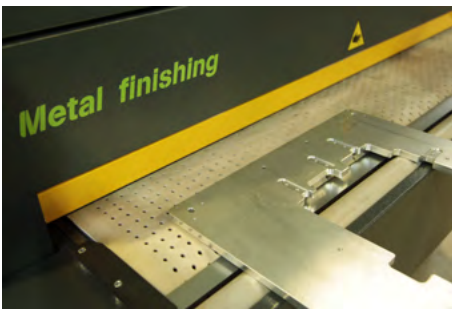

PP + abrasive

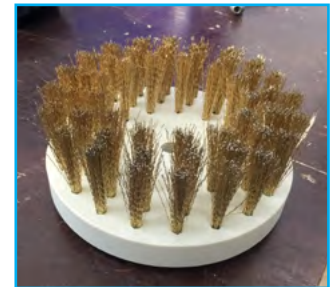

Steel

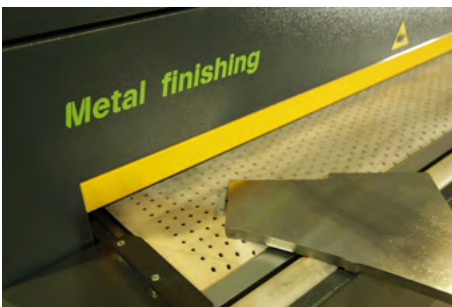

# Fiber Laser type Smartline

Best  
Quality

Made in  
EU  
★★★



Smartline 3015

TCI Smartline Fiber Laser series consists of innovative, high-quality machines, manufactured in Spain offering high productivity and minimal maintenance costs. The compact design of Smartline makes it extremely space-saving. It is a high-precision machine with high cutting speeds.

Smartline is equipped with a Precitech cutting head. Easy processing of copper, titanium and brass. All components are delivered from world-class manufacturers and/or are developed and manufactured by TCI.

Various kinds of accessories and components can be delivered for the Smartline Fiber Laser.

## The most important features for Smartline Fiber Laser:

- Compact design.
- CNC with laser control.
- Resonator with reflecting sensors.
- Power output control function for automatic nesting and machining (corners, lead-ins).
- Extremely dynamic equipment.
- Rigidity: transmission of high speed due to the stable construction.
- Safety: Class IV systems.
- Y-axis: 1 motor / X-axis: 2 motors that run synchronously.
- Optimal operator safety in the cutting area.
- The machine is protected against vibrations.
- Easy programming with CAD/CAM software.
- Low cooling capacity due to the fibre optics.
- Reduced operational costs due to a modern motor control system with a low power consumption.



Precitech cutting head

# Fiber Laser type Smartline

Best  
Quality

Max. permitted load	950 kg/m <sup>2</sup>
Cutting heads	1 pc.
Max. positioning speed	160 m/min.
Axial acceleration	19,6 m/s <sup>2</sup>
Acceleration	2G
Max. tolerance	± 0,05 mm/m
Repeatability precision	± 0,025 mm/m
Power output (IPG)	1 - 6 kW

## Optional equipment:

- Loading/unloading system
- Exhaust system
- Rofin fiber laser resonator
- Piercing sensor
- Collection of workpieces and trimmings
- Tower system 4.0
- Dual proportional valve control system for different gas pressures and special system for high-pressure cutting
- CNC Fanuc 31iLB
- Aut. nozzle cleaning
- Aut. focus control
- MultiTouch screen with remote control
- Ultra fast height regulation
- TCI Smart Touch 6.0
- TCI Fly Cutting 3.0
- TCI Fast Piercing 2.0
- TCI aut. cutting system 3.2 (aut. job list)

## Standard equipment:

- Cutting table
- Cabinet (for the laser control)
- IPG fiber laser resonator
- Precitec cutting head
- TCI HMI 5.0 machine software
- CAD/CAM software, Lantek Expert Cut
- Automatic table exchanger (some models)
- Cooling system
- Exhaust system with filter
- Class IV safety system CE-approved



Loading/unloading



Tower system

Type	Watt	Cutting length	Cutting width	Cutting capacity
	W	X - mm	Y- mm	Z - mm
Smartline 3015	1000-6000	3000	1500	100
Smartline 4020	1000-6000	4000	2000	100

# Fiber Laser type Speedline

Best  
Quality

Made in  
EU  
★★★



Speedline 3060

TCI Speedline Fiber Laser series consists of innovative, high-quality machines, manufactured in Spain offering high productivity and minimal maintenance costs. The series offers unmatched parts production and excellent cutting quality in accordance with the laser power for thin sheets and sheets of medium thickness.

The very energy efficient fiber laser ensures highly reduced electricity consumption. Speedline is equipped with Precitech cutting head, and it is able to cut in numerous kinds of material and thicknesses. All components are delivered from world-class manufacturers and/or are developed and manufactured by TCI.

Various kinds of accessories and components can be delivered for the Speedline Fiber Laser.

## The most important features for Smartline Fiber Laser:

- Compact design.
- CNC with laser control.
- Resonator with reflecting sensors.
- Power output control function for automatic nesting and machining (corners, lead-ins).
- Extremely dynamic equipment.
- Rigidity: transmission of high speed due to the stable construction.
- Safety: Class IV systems.
- Y-axis: 1 motor / X-axis: 2 motors that run synchronously.
- Optimal operator safety in the cutting area.
- The machine is protected against vibrations.
- Easy programming with CAD/CAM software.
- Low cooling capacity due to the fibre optics.
- Reduced operational costs due to a modern motor control system with a low power consumption.



Precitech cutting head

# Fiber Laser type Speedline

Best  
Quality

Max. permitted load	950 kg/m <sup>2</sup>
Cutting heads	1-2 pcs.
Max. positioning speed	160 m/min.
Axial acceleration	19,6 m/s <sup>2</sup>
Acceleration	2G
Max. tolerance	± 0,05 mm/m
Repeatability precision	± 0,025 mm/m
Power output (IPG)	1 - 6 kW

## Optional equipment:

- Loading/unloading system
- Exhaust system
- Rofin fiber laser resonator
- Piercing sensor
- Collection of workpieces and trimmings
- Tower system 4.0
- Dual proportional valve control system for different gas pressures and special system for high-pressure cutting
- CNC Fanuc 31iLB
- Aut. nozzle cleaning
- Aut. focus control
- MultiTouch screen with remote control
- Ultra fast height regulation
- TCI Smart Touch 6.0
- TCI Fly Cutting 3.0
- TCI Fast Piercing 2.0
- TCI aut. cutting system 3.2 (aut. job list)

## Standard equipment:

- Cutting table
- Cabinet (for the laser control)
- IPG fiber laser resonator
- Precitec cutting head
- TCI HMI 5.0 machine software
- CAD/CAM software, Lantek Expert Cut
- Automatic table exchanger (some models)
- Cooling system
- Exhaust system with filter
- Class IV safety system CE-approved

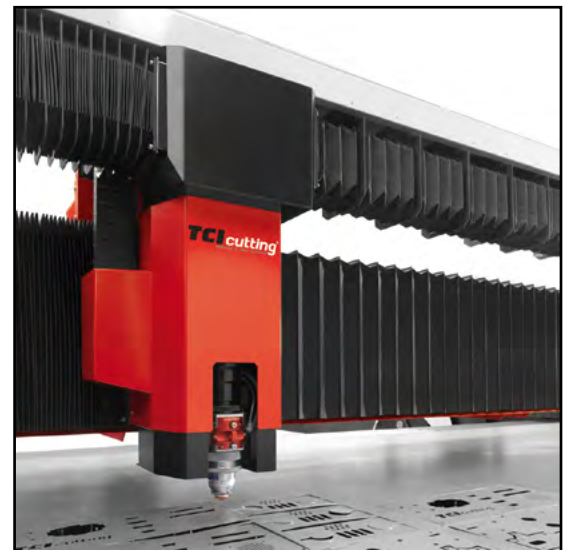

Type	Watt	Cutting length	Cutting width	Cutting capacity
	W	X - mm	Y - mm	Z - mm
Speedline 3015	1000-6000	3000	1500	100
Speedline 4020	1000-6000	4000	2000	100
Speedline 6020	1000-6000	6000	2000	100
Speedline 6030	1000-6000	6000	3000	100

# Fiber Laser type Smartline & Speedline

Best  
Quality

## Controls:



CNC S650



Mach One



SmartTouch HMI V 6.0

## Fiber Laser resonator:

- Smartline and Speedline have integrated IPG fiber laser source
- The fiber laser resonator is kinetically suspended
- Power: 1 - 6 kW
- Contains communication system with control unit and closed cooling circuit
- Direct control of all fiber laser functions
- General power management
- High speed perforation
- Edge processing function
- Cutting library/cutting data
- Fly-Cutting



IPG resonator



Rofin resonator

# Tube Laser Cutting machine type Smarttube

Best  
Quality

Made in  
EU  
★★★



TCI Smarttube tube laser machines with fiber source are innovative machines of very high quality, manufactured in Spain with an emphasis on production optimisation and the latest technology. Smarttube, with its compact design, is extremely space-saving.

The tube laser is capable of machining pipes up to  $\varnothing 220$  mm. Smarttube can handle various types of pipes, as well as open and closed profiles.

## Features for Smarttube Fiber Laser:

- Compact design.
- Reduced power consumption.
- Industrial ethernet enabled touch panel.
- Hydraulic working vices with proportional valve system.
- Two belt conveyor modular unloader
- CAD/CAM integrated solution with the possibility to import external files, integrated system for drawing, optimization and nesting of tubes and profiles. System with enclosed database for technological tables for cut.

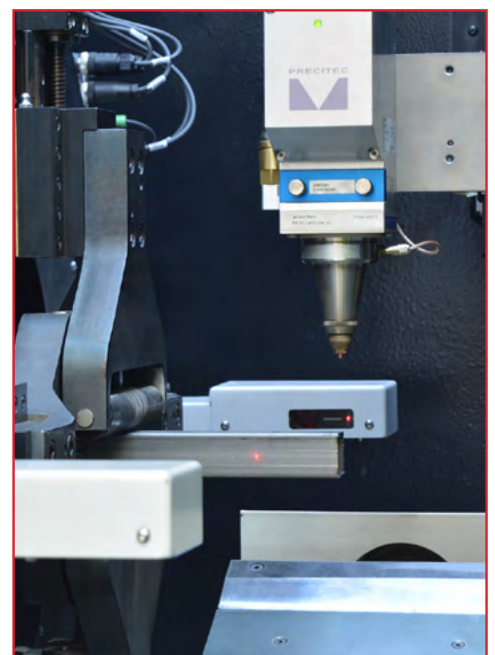

# Tube Laser Cutting machine type Smarttube

Best  
Quality

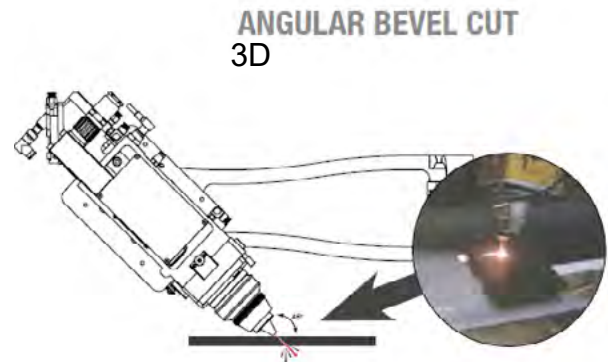
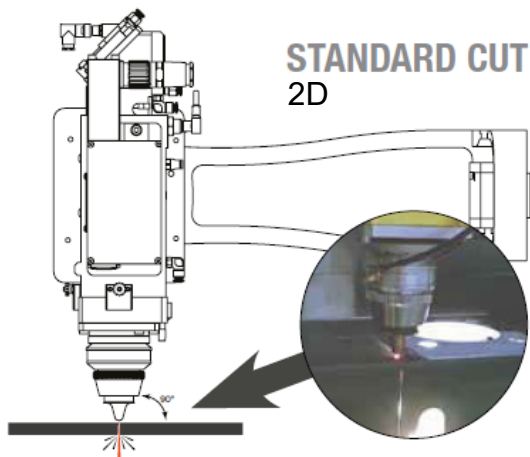

## Specifications:

- IPG Resonator 1 - 4 kW
- Precitec Light Cutter cutting head
- Fully enclosed and cabined machine
- Effective system to change from high to low gas pressure
- Capacitive sensor
- TCI Cutting parameter tables
- Pre-cut protective film
- Automatic time and cost calculation for pieces
- Network connection via external PC
- Smoke extraction system
- Tube length measuring sensor
- Dual proportional valve system for gas pressures
- Special system for high pressure cutting
- ESA CNC
- Cooling system
- Ultra fast height regulation
- TCI Smart Touch 6.0

Smarttube Fiber	120	220
Max. load	20 kg/m	40 kg/m
Cutting heads	1 pc. - 2D	1 pc. - 2D or 3D
Max. simultaneous positioning speed	50 m/min.	50 m/min.
Max. axial acceleration	9,8 m/s <sup>2</sup> (1G)	6 m/s <sup>2</sup>
Machine tolerance	± 0,05 mm/m	± 0,05 mm/m
Repeatability precision	± 0,03 mm/m	± 0,03 mm/m
Motor	1 kW to 2 kW	1 kW to 4 kW
Supported formats	Round, square, rectangular	
Tube dimensions	Ø20 to Ø120 mm	Ø20 to Ø220 mm
Max. length	6000 / 8000 / 12000 mm	
Collection of workpieces	Optional	Optional
Finished pieces extraction	Optional	Optional



# Waterjet cutting machine type SM-C 3015

Best  
Quality

Made in  
EU  
★★★



TCI Cutting has a vast experience in the design and manufacturing of industrial high precision waterjet cutting machines, and are leading in the market. A compact design makes the machine extreme space saving. The machine uses an ultra-high water pressure, which gives you a unique cutting capability.

The flexible TCI waterjet cutting machines are capable of cutting all kinds of material, even material with painted surfaces. The machine makes a clear cut, and the surface of the material stays even and without cracks, which means that you avoid material loss.

Very profitable, both regarding small series and long repetitive series.

Type SM-C 3015 waterjet comes with various high-pressure pumps and various cutting heads depending on the job to be carried out and the material.



Type	Max. thickness	Max. load	Cutting heads	Positioning speed	Max. cutting speed	Max. tolerance	Repeatability precision	Dimension
	mm	kg/m <sup>2</sup>	Stk.	m/min.	m/min.	mm/m	mm/m	mm
SM-C 3015	200	790	1	85	20	± 0,05	± 0,025	3000x1500x200

# Waterjet/Plasma cutting machine type SM-S & SM-M

Best  
Quality

Made in  
EU  
★★★



SM-M 3020

TCI waterjet-/plasma cutting machines type SM-S & SM-M are innovative, flexible combination machines of extremely high quality, manufactured in Spain, using the newest technology for product optimization. The machines can handle all types of jobs, and you have the possibility of using two independent cutting arms, located in two different work areas.

The SM-M series machine allows both the installation of a second independent cutting table as well as the extension of the main cutting table, thereby maximizing performance.

SM-M also offers the option of enclosure to facilitate clean and silent functioning and occupying minimal space.

A plasma head can be built onto type SM-S.

The machines are very profitable, especially due to the fact that you can run several work processes simultaneously.

Type SM-S & SM-M come with various high-pressure pumps and various cutting heads depending on the job to be carried out and the material.



SM-S 6020

Type	Max. thickness	Max. load	Cutting heads	Positioning speed	Max. cutting speed	Max. tolerance	Repeatability precision	Dimension
	mm	kg/m <sup>2</sup>	Stk.	m/min.	m/min.	mm/m	mm/m	mm
SM-S 3015	200	790	1	85	20	± 0,05	± 0,025	3000x1500x200
SM-S 3020	200	790	1	85	20	± 0,05	± 0,025	3000x2000x200
SM-S 4020	200	790	1	85	20	± 0,05	± 0,025	4000x2000x200
SM-S 6020	200	790	1	85	20	± 0,05	± 0,025	6000x2000x200
SM-M 3015	200	790	1-2	85	20	± 0,05	± 0,025	3000x1500x200
SM-M 3020	200	790	1-2	85	20	± 0,05	± 0,025	3000x2000x200
SM-M 4020	200	790	1-2	85	20	± 0,05	± 0,025	4000x2000x200
SM-M 6020	200	790	1-2	85	20	± 0,05	± 0,025	6000x2000x200

# Waterjet/Plasma cutting machine type BP

Best  
Quality

Made in  
EU  
★★★



BP-C (Compact) 4020

TCI waterjet-/plasma cutting machines type BP are innovative, flexible combination machines of extremely high quality, manufactured in Spain, using the newest technology for product optimization. Type BP is characterized by a bridge-type construction, which gives great robustness and enables to cut large surfaces.

The gantry drive system on the Y-axis allows high acceleration and high speed thus reducing operating time.

BP-S, BP-M and BP-H can all be expanded in length by adding new modules. Max. no. of bridges of BP-S & BP-M are 4 pcs. A plasma head can be built onto all BP models.

The machines come with various high-pressure pumps and various cutting heads depending on the job to be carried out and the material.

## Fields of application:

- Aeronautics (alloys, titanium, etc.)
- Food (chocolate, fish, etc.)
- Automotive (rubber, composites, etc.)
- Construction (iron, marble, ceramics, etc.)
- Metallurgy (stainless steel, brass, etc.)
- Toys (foams, synthetic fibers, etc.)
- Furniture (glass, wood, fabrics, etc.)
- Advertising (plexiglas, PVC, vinyl, etc.)



BP-S (Standard) 3060



BP-H (High) 3040



BP-M (Modular) 4060

# Waterjet/Plasma cutting machine type BP

Best  
Quality

## Advantages and characteristics:

- Travel speed up to 85 m/min.
- “Smart system” for moving up to 4 independent cutting heads, allowing maximum utilization of materials.
- Real time consumable status monitoring software allows preventive maintenance and downtime prevention.
- Fully automated sludge removal system.
- CNC, control cabinet, intensifier and peripherals are shielded from the working area of the machine.
- Possibilities for both frontal and lateral loading of materials.
- Autonomous functioning system.
- Anti-collision system with digital sensitivity regulation.



Type	Max. thickness	Max. load	Cutting heads	Positioning speed	Max. cutting speed	Max. tolerance	Repeatability precision	Dimension
	mm	kg/m <sup>2</sup>	Stk.	m/min.	m/min.	mm/m	mm/m	mm
BP-C 4020	200	790	1-2	85	20	± 0,05	± 0,025	4000x2000x200
BP-S 3015	200	790	1-4	85	20	± 0,05	± 0,025	3000x1500x200
BP-S 3020	200	790	1-4	85	20	± 0,05	± 0,025	3000x2000x200
BP-S 2040	200	790	1-4	85	20	± 0,05	± 0,025	2000x4000x200
BP-S 3060	200	790	1-4	85	20	± 0,05	± 0,025	3000x6000x200
BP-S 3080	200	790	1-4	85	20	± 0,05	± 0,025	3000x8000x200
BP-S 4060	200	790	1-4	85	20	± 0,05	± 0,025	4000x6000x200
BP-S 4080	200	790	1-4	85	20	± 0,05	± 0,025	4000x8000x200
BP-M 2040	200	1000	1-4	85	20	± 0,05	± 0,025	2000x4000x200
BP-M 3020	200	1000	1-4	85	20	± 0,05	± 0,025	3000x2000x200
BP-M 3060	200	1000	1-4	85	20	± 0,05	± 0,025	3000x6000x200
BP-M 3080	200	1000	1-4	85	20	± 0,05	± 0,025	3000x8000x200
BP-M 30120	200	1000	1-4	85	20	± 0,05	± 0,025	3000x12000x200
BP-M 4060	200	1000	1-4	85	20	± 0,05	± 0,025	4000x6000x200
BP-M 4080	200	1000	1-4	85	20	± 0,05	± 0,025	4000x8000x200
BP-M 40120	200	1000	1-4	85	20	± 0,05	± 0,025	4000x12000x200
BP-H 3015	200	790	1-4	85	20	± 0,05	± 0,025	3000x1500x500
BP-H 3020	200	790	1-4	85	20	± 0,05	± 0,025	3000x2000x500
BP-H 2040	200	790	1-4	85	20	± 0,05	± 0,025	2000x4000x500
BP-H 3060	200	790	1-4	85	20	± 0,05	± 0,025	3000x6000x500
BP-H 3080	200	790	1-4	85	20	± 0,05	± 0,025	3000x8000x500
BP-H 4060	200	790	1-4	85	20	± 0,05	± 0,025	4000x6000x500
BP-H 4080	200	790	1-4	85	20	± 0,05	± 0,025	4000x8000x500

# Waterjet/Plasma cutting machine type SM & BP

Best  
Quality

## Direct Drive 3800 waterjet pump

The use of Direct Drive waterjet pumps is recommended for use in applications where the flow rate rather than the actual pressure is most important, especially with low pressure multiple-head applications. This type of pump uses an electric motor to turn the crankshaft attached to 3 or more pistons which generate the pressure and the water flow. Cooling equipment not required. Suitable for low pressure cutting where delamination occurs. Work pressure up to 3800 bar.

## SL-V Plus 4100 waterjet pump

The latest generation of SL-V Plus waterjet pumps offers the most advanced waterjet technology with working pressures up to 4100 bar, allowing cutting with the highest speeds and achieving the cleanest cuts.

## Streamline PRO 6200 waterjet pump

Streamline PRO 6200 offer a new range of products, which provide a breakthrough in the world of waterjet cutting. "PRO" stands for waterjet cutting technology with working pressures up to 6500 bar. It contains all the components necessary for this, from the generation of high pressure to the nozzle, which directs the waterjet onto the selected material. The pressure of 6200 bar is an increase of almost 50% compared to conventional pressure ranges.



Direct Drive 3800



SL-V Plus 4100



Streamline PRO 6200

Type	Nominal power	Working pressure	Max. water flow	LxBxH	Weight	Max. no. nozzles (Ø mm)		
						0,25	0,30	0,35
	HP	bar	l/m	mm	kg			
DD 3800	30	op til 3500	3,1	1400x1000x1600	450	2	1	1
DD 3800	40	op til 3800	6,4	1860x1300x1700	730	3	2	2

Type	Nominal power	Working pressure	Max. water flow	Accum. capacity	Tank capacity	LxBxH	Weight	Max. no. nozzles (Ø mm)			
								0,17	0,25	0,33	0,35
	HK	bar	l/m	l	l	mm	kg				
SL-V 4100	30	500-4136	2,6	1	150	1689x1114x1477	1131	2	1	-	-
SL-V 4100	40	500-3800	2,7	1	144	1436x1167x1005	975	3	1	-	-
SL-V 4100	50	500-3800	4,3	1	150	1689x1114x1477	1302	4	2	1	1
SL-V 4100	50 P	500-4136	4,1	2	150	1689x1114x1477	1324	4	2	1	1
SL-V 4100	100	500-4136	7,6	2	211	2095x1320x1508	2128	8	4	2	2
PRO 6200	60	800-6200	2,8	1,6	211	2095x1320x1973	2130	2	1	-	-
PRO 6200	125	800-6200	6,0	1,6	416	2238x1500x1552	3107	5	2	1	1

# Waterjet/Plasma cutting machine type SM & BP

Best  
Quality

## Optional equipment:



5-axis cutting head, 90° angle cutting, 3D, patented design, full rotation.



Automatic abrasive regulator. Stops automatically when the abrasive has been used up.



Autonomous "non-return" system, prevents water and abrasive from rising up if jammed during the cutting process.



Electronic collision system for the cutting heads, stops the machine before damages occur.



Automatic pneumatic dosing of abrasive incl. sensor. Capacity 200 L.



Equipment for pre-drilling of fragile and multi-laminated composites. Possible to mount different drill bit diameters.



Fully automatic sludge cleaning system. Collects sludge, separates water from the sludge and recirculates it back into the tank.



Water cooling system for hydraulic oil of the intensifier pumps with a closed water circuit.



2000 kg hopper for machines with high production output.



Water treatment equipment. Conditions the water before entering the intensifier.



Height regulation system ensures constant distance between the nozzle and the cutting material, enabling cutting in uneven surfaces.



Laser pointer



Jet Control - eliminates conicity on parts by means of tangential cutting function programmed in the CNC system to transform it to 5 axes.

# Kimtech waterjet cutting machines

Best  
Quality

Made in  
EU  
★★★

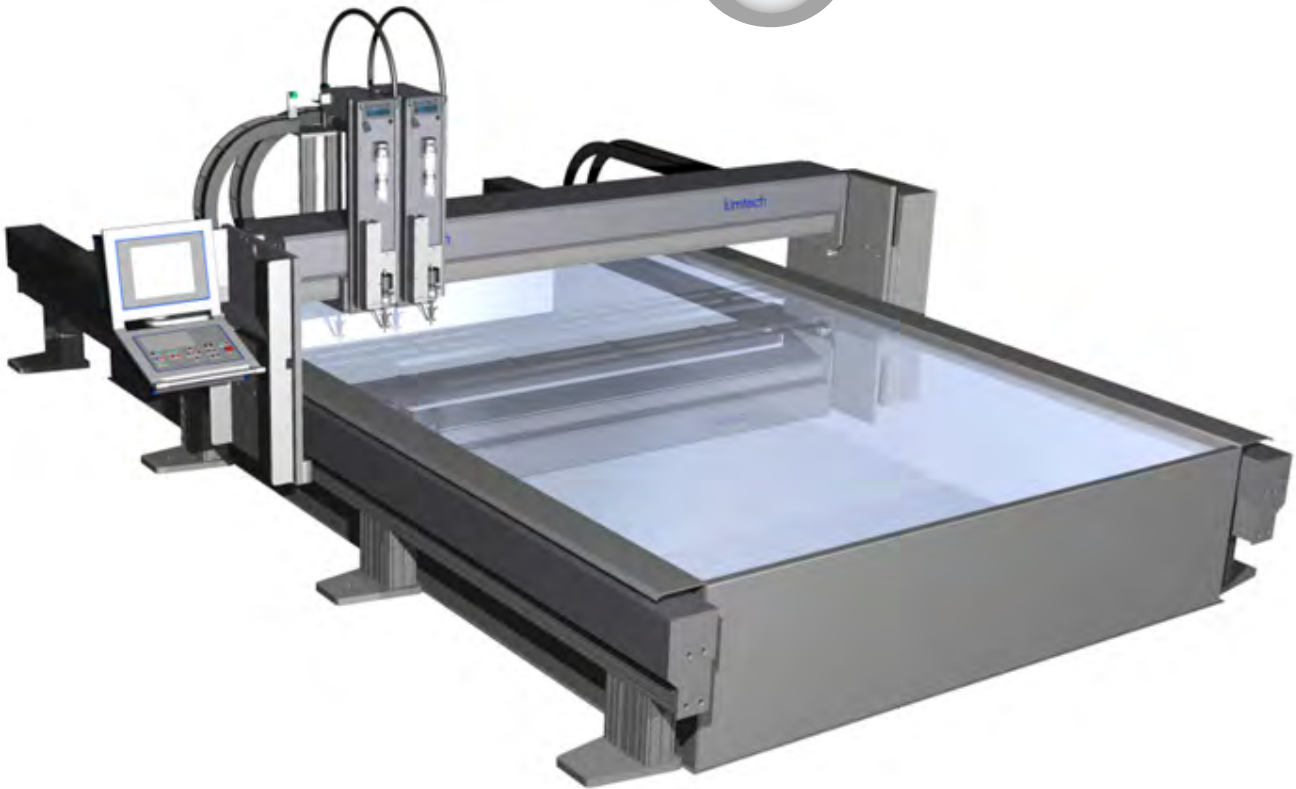

**Kimtech's waterjet machines** are developed and manufactured in Sweden. They are precision CNC-controlled machines using cutting edge technology to deliver an easy to operate, reliable cutting solution. The cut from abrasive waterjet cutting has a tolerance from 0.1 mm to 0.5 mm, depending on the thickness of the plate. The advanced software control of the machine delivers very high position accuracy, <0.10 mm. Kimtech works throughout Scandinavia and Europe. To ensure a high quality of expert support and service, Kimtech has several co-operation partners including LB-service, Indutech, NK-Service and Arvór System. Kimtech has delivered waterjet cutting machines from 0.5x1m up to 4x20m. All machines uses a range of techniques for linear movement including precision ball screws, linear motors and rack & pinion drive. The most suitable technique depends on the customer's request for acceleration, speed and accuracy.

Kimtech has three standard machines that cover most applications but we also regularly build fully customized special machines.

## Standard machines

XY-SMALL	3100x1600	Art.No: 24640
XY-MEDIUM	2100x4200	Art.No: 24641
XY-LARGE	3100x6300	Art.No: 24642

## Special machines:

XY-MINI	1x0,5 meter	Art.No: 26645
XY-X LARGE	4x14 meter	Art.No: 26646
XY-WIDE	6x2 meter	Art.No: 26647

# Kimtech waterjet cutting machines

Best  
Quality

Made in  
EU  
★★★



## Specifications XY-SMALL

- Suited for 2x1m plates
- Optional automatic altitude control
- Operating system specially adapted to water cutting
- Machine Building in stainless steel and aluminum
- Ergonomic control panel
- Ball screw on all axes
- Water container in stainless steel

## Specifications XY-MEDIUM

- Suited for 3x1,5 and 2x1m plates
- Possibility of 2 beams
- Optional automatic altitude control
- Operating system specially adapted to water cutting
- Machine Building in stainless steel and aluminum
- Ergonomic control panel
- Ball screw on all axes
- Water container in stainless steel

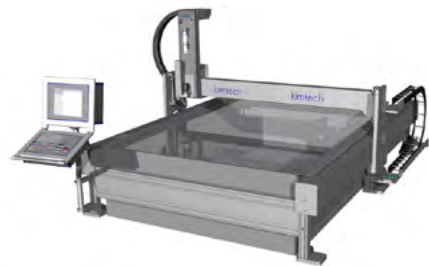

## Specifications XY-LARGE

- Suited for 6x2 and 3x1,5m plates
- Possibility of 2-4 beams
- Optional automatic altitude control
- Operating system specially adapted to water cutting
- Machine Building in stainless steel and aluminum
- Ergonomic control panel - following crossbar
- Linear motors on all axes
- Water container in stainless steel



## Control unit

- Software developed specifically for waterjet cutting
- Graphical color picture of the NC program
- Ability to go backwards in the NC program
- Zero-coordinate can be placed over the entire operating range
- Ability to rotate the coordinate system in case of angled plate
- Zoom function
- Fast response time
- Very user-friendly
- Online radius compensation
- Optional GSM monitoring

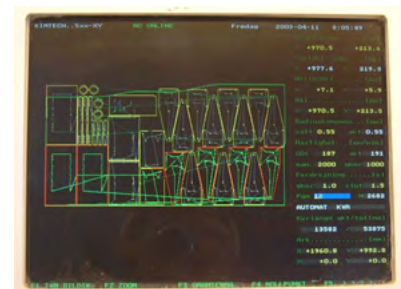



# Kimtech waterjet cutting machines

Best  
Quality

Made in  
EU  
★★★

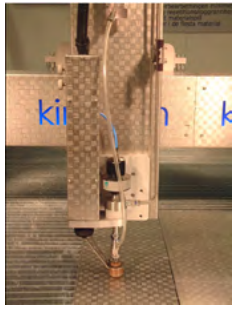

## Automatic cutting distance

High-precision cutting head designed to automatically keep the same distance from the material. Highly accurate sensors ensure extreme accuracy. AC servo-driven Z-axis.

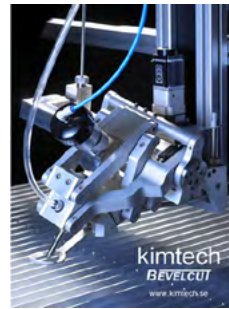

## Bevel Cutting

High-precision cutting head designed for angled cutting of flat materials. Kimtech has developed its own system with extremely high precision, which is achieved through constant monitoring of the nozzle height and material.

## Nesting

In order to use computers to quickly transfer various geometrical shapes on a surface with arbitrary geometric shape nesting is a necessity. Kimtech machines using IGEMS which have been shown to be among the most effective systems for handling algorithms. IGEMS is able to deal with virtually any object, varies from a simple line, to large complex geometries.

The system supports include DWG, DXF, WMF, CNC and IGS.

## Auto-Nesting

The system automatically places the cuts on one or more plates. Nesting of multiple parties with different requirements at the same time, means that each process can have individual differences, why auto-nesting is a very effective tool. Auto nesting handles every single set, and automatically places them most effectively. This implies that the parties can be turned, turned upside down, or placing the minor parties in the larger parties cavity, all automatically to avoid waste.

Auto nesting handles parties and panels of any geometric shape.

## Report

Nesting solution includes a report generator, for the presentation of the produced results. This includes information about the number of parties, the completion rate and total cutting length.

## Pump

The main component of a water jet cutter is the high pressure pump that supplies water with a pressure of up to 4100 bar. Number of cutting heads are depending on the size of the HP pump. Kimtech water jet cutter is supplied with pumps in sizes from 22 kW to 75kW.

The pump is exposed to an enormous pressure when this handles pressures up to 4100 bar over a long time. In the Swedish and Northern European market, pumps manufacturer FLOW proved to be the only one who are able to handle this task. This is the reason that all the machines are provided with Kimtech FLOW pumps.

## Spare parts

Kimtech have a full spare part stock for all machines and pumps, which means that downtime is reduced to an absolute minimum. This means delivery 1-2 days throughout Scandinavia.

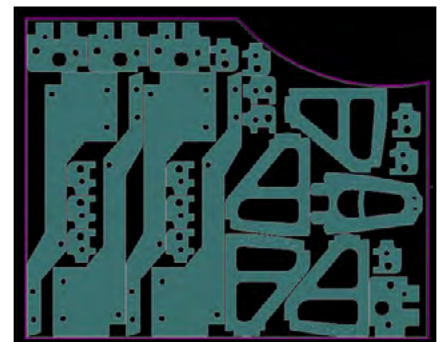

# Produtech fiber laser type ISEO

Best  
Quality

Made in  
EU  
★★★



Produtech fiber laser type ISEO is a newly developed innovative machine that revolutionises workflow in cutting sheet metal directly from the coil. The benefits of handling thin sheet directly from the coils are many, which includes no limitation in handling of the material length. The continuous feeding of material ensures high productivity. The latest fiber laser technology provides unique cutting quality, high precision and impressive cutting speed. The technology within fiberlaser, is very energy efficient, with a minimum of maintenance costs. Type ISEO is suitable both for the production of steel, aluminum, brass and copper. The workspace is completely covered, and ensure that the machine meets all safety requirements.

## Coil feeding system:

The system consists of rolls via rectified rubber coating provides high resistance, which is driven by a brushless motor. This guarantees constant control of the positioning of the coil during the routine work and avoids many drawbacks (ie the need for multiple restarts or using clamps) and thus ensures speed and accuracy.

## Laser source:

The laser source is provided by IPG from Germany, which is the largest supplier in the market for fiber lasers. The laser cutting head is also from IPG, so we ensure the best possible use of the products.

## Coiler:

Coil-launcher is a heavy-duty model. The structure is designed and constructed of thick electro-welded steel, annealed and processed with high precision. It has a hydraulic expansion of the mandrel to move inside the coil. This allows for an easy and quick replacement. The rotation is performed by a hydraulic motor with gear unit, which can finely adjust the speed, and is automatically controlled by an electro-mechanical device. Another electromechanical device control the "loop". The coiler unit is equipped with a motorized rotating arm, which ensures that no "rollback" occurs, and that the coil always have the correct settlement.



# Produtech fiberlaser type ISEO

Best  
Quality

## Cutting head:

Designed with innovative technologies and assembled with quality parts, the cutting head is mounted on the machine by guides that are sufficient, hardened and rectified, with ball screws. The lateral movement (y-axis) along the entire width, is made of the latest generation of linear motors, manufactured by the best brands, ensuring high reliability, precision and speed without the need for gears. Therefore, the head can obtain:

- High speed.
- High positioning accuracy.
- Minimal maintenance.



## X-a axis:

The purpose of the extra X-a axis, to achieve higher performance in fiber-laser line.

Produtech designed the additional axis which makes the cutting head to move in the same direction as the material. This extra axis moves via. A very fast and precise linear motor.

Both Xa and Y-axis movement is controlled by linear motors with very high precision,

When the client needs to cut larger shapes, long parts or radii, the machine will set the standby position Xa axis and will work with interpolation of the X and Y axis.

## Control unit:

CNC control is provided by ESA GV (mod. S500). The user interface is an industrial PC with TFT LCD 12.1 "display and a separate keyboard is mounted on a panel.

## Straightening-unit:

This unit is made of a "heavy-duty" construction, the structure consists of thick electro-welded steel, annealed and processed by high precision.

There are 4 pieces motorized rollers for conveying the material, which is made of chrome-plated steel, they are powered by a brushless motor and placed before and after the straightening unit, which guarantees the highest precision. Straightening-rollers are

made of chrome plated steel with a hardened surface. The top rollers are vertically

movable by hand-wheel, with a digital position indicator to allow fine tuning.



Art.nr	Type	Coil width	Sheet thickness	Source	Control unit	Straightening rollers	Straightening rollers	Straightening rollers
		mm	mm	kw		mm Ø	Numbers	Feeding
24980	ISEO A2	1500	5	0,4 ; 1 ; 2	ESA	120	6	4

# EKI coil processing line type XSLINE

Best Quality

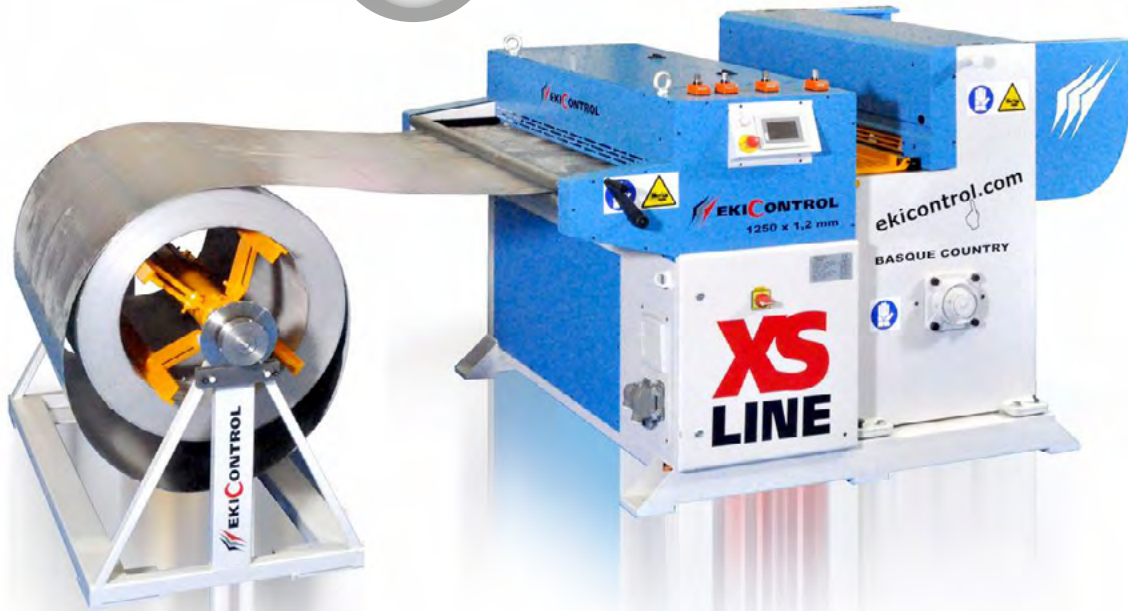

EKI Control coil processing line type XSLINE is a cut-to-length line in a compact design with easy access to any part of the machine with maximum security for the operator. The XSLINE is equipped with user-friendly integrated software. A unique feature is the ability to adapt the lines to each customer's needs, e.g. trapezium cutting lines, lines with flying shears and grinding-polish cutting lines, complete cutting lines including uncoilers, coil cars, strip straighteners, slitters, shears, stackers, tensioning presses and strip recoilers.

The machines are 100% European using only European components of the highest quality.

Material to process:

Carbon Steel 420 N/mm<sup>2</sup>– Aluminium 220 N/mm<sup>2</sup> - Stainless 700 N/mm<sup>2</sup>

## Standard:

- Entry guide
- 5 straightening rolls
- 2 feeding rolls
- Slitting edge with 3 pairs of fast adjustable blades
- Electrical cut-to-length shear
- Touch screen CNC

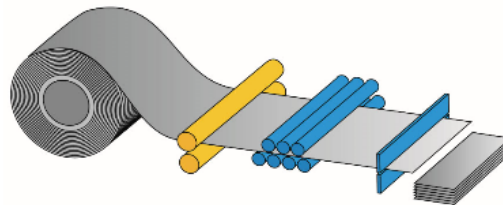

Type		1050 x 1,5 mm	1250 x 1,25 mm	1500 x 1,0 mm
Coil weight	ton	3 - 6 - 10 - 15	3 - 6 - 10 - 15	3 - 6 - 10 - 15
Coil width	mm	1050	1250	1500
Straightening rolls	pcs.	2 + 5	2 + 5	2 + 5
Max. capacity thickness	mm	3	3	3
Speed	m/min.	0 - 20	0 - 20	0 - 20

# EKI coil processing line type ONECUT

Best  
Quality

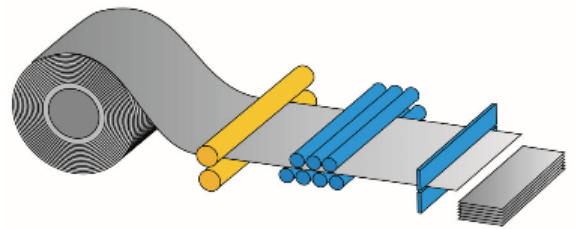

EKI Control coil processing line type ONCECUT is a cut-to-length line in a compact design with easy access to any part of the machine with maximum security for the operator. ONECUT is equipped with user-friendly integrated software. A unique feature is the ability to adapt the lines to each customer's needs, e.g. trapezium cutting lines, lines with flying shears and grinding-polish cutting lines, complete cutting lines including uncoilers, coil cars, strip straighteners, slitters, shears, stackers, tensioning presses and strip recoilers.

The machines are 100% European using only European components of the highest quality.

Material to process: Carbon Steel - Aluminium - Stainless

## Standard:

- Entry guide
- Feeding rolls
- 7 straightening rolls
- Line encoder
- Cut-to-length shear



Type		ONECUT 20	ONECUT 30	ONECUT 40
Coil weight	ton	5 - 10 - 15	10 - 15	10 - 15
Coil width	mm	1050 - 1250 - 1500	1050 - 1250 - 1500	1500
Thickness	mm	0,5 - 2,5	0,6 - 3,0	0,8 - 4,0
Straightening rolls	pcs.	2 + 7	2 + 9 + 2	2 + 9 + 2
Speed	m/min.	0 - 20	0 - 30	0 - 40

# EKI coil processing line type Compact

Best  
Quality

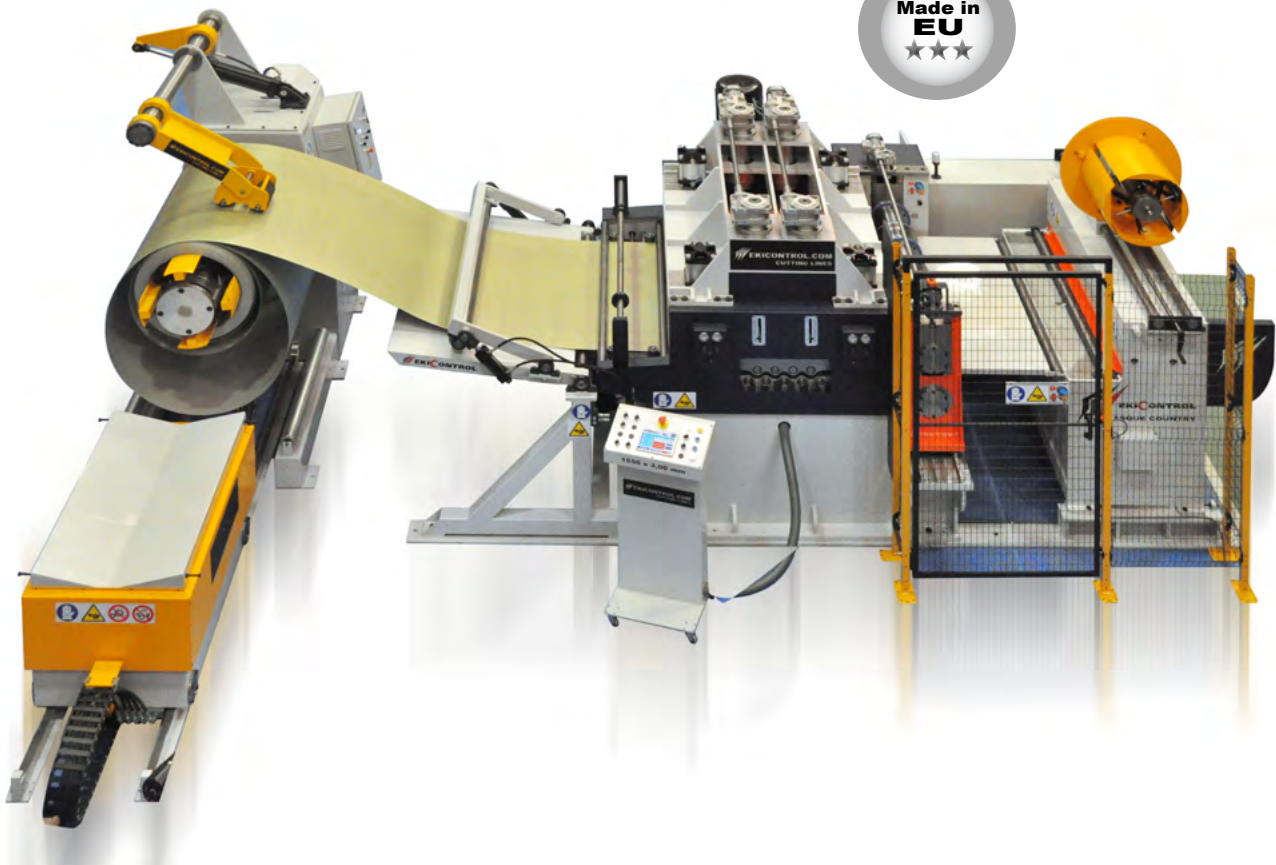

EKI Control coil processing line type COMPACT is a slitting and cut-to-length line with straightener, all placed on the same common base. Electric equipment and touch screen for programming are integrated into the structure of the machine. The machines are 100% European using only European components of the highest quality. The line has a 10-ton loading capacity of coil.

This line has 4 autocentering tiles and hydraulic expansion, which give a good tightening and fixation of the coil in the mandrel. The machine is equipped with a hydraulic pressure arm that can be motorised. The stable and safe coil car with all hydraulic movements gives you strength at loading coils in the uncoiler. The entry table leads a band to the tilting straightener and makes the loading easier to the operator.

Type		1500 x 2 mm		1500 x 4 mm	
		TWINCUT20	TWINCUT30	TWINCUT30	TWINCUT40
Coil weight	ton	6 - 10 - 15 - 20	6 - 10 - 15 - 20		
Coil width	mm	1050 - 1250 - 1500	1050 - 1550	1050 - 1550	
Max. thickness R $\geq$ 420 N/mm <sup>2</sup>	mm	2,0	3,0	4,0	
Max. thickness	mm	3,0	-		
Min. thickness R=420 N/mm <sup>2</sup>	mm	0,5	0,6	0,8	
Production speed	m/min.	20	30	40	
Simultaneous slitting cuts at the max. thickness	pcs.	3 (up to 8)	-		
Straightening rolls	pcs.	2 + 7	2 + 9 + 2		
Straightening regulation		Manual	Motorised		
Servo motor		Yes	Yes		

# EKI coil processing line type Compact

Best  
Quality

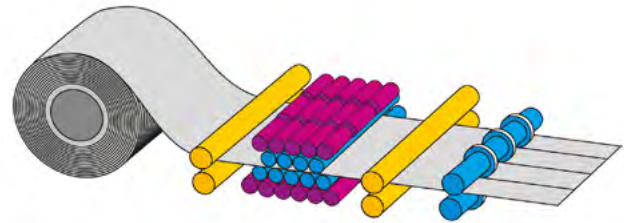
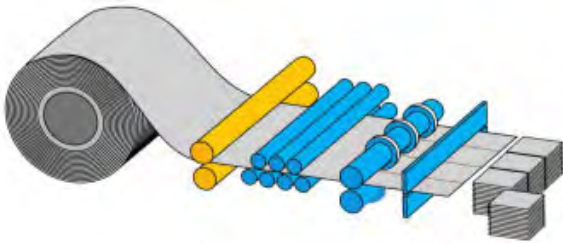

## Standard:

- Uncoiler with hydraulic pressure arm
- Hydraulic coil car
- Pneumatic entry table
- Straightener of 9 rolls, 2 feeding and 7 straightening
- Slitting unit with fast adjustment of circular blades
- Folding table between shears
- Shear for cut-to-length

## Optional:

- Hydraulic entry table
- Motorised pressure arm
- Paper recoiler & film plastic device
- Specific electronic equipment
- Stackers, packagers
- Scrap rewinders (cleaning)
- Coil loading arm
- Blades for centering coil

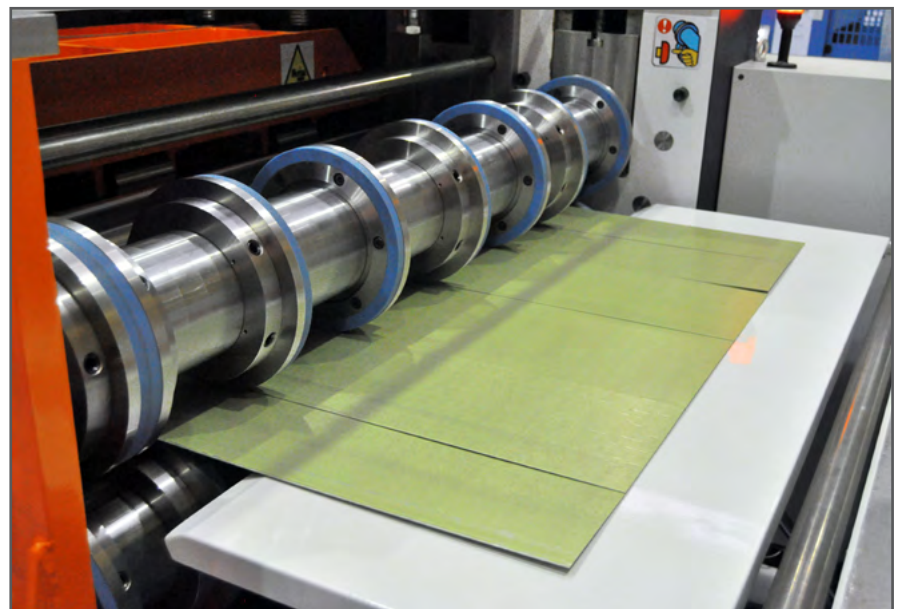

# Erbend Folding Machine type UFA

Best  
Quality



**Erbend manual folding machine type UFA** is a sturdy machine with segmented beams. Segmented tools for quick and easy clamping is standard.

### Standard equipment:

- Vertical clamping beam with 200 mm opening height
- Easy tool clamping system for faster set-up
- Segmented tools for clamping beam, h:100 mm, foot width:56 mm
- Segmented folding beam tools, h:60 mm
- Segmented lower beam tools, h:92 mm
- 500 mm manual back gauges and tools cabinet
- Wheels with brakes
- Bending angle stabilization unit
- Clamping beam stabilizer arm, depressor arm and stabilizer foot pedal

- Capacity steel: max.1.5 mm.
- Capacity aluminum: max.2.2 mm.
- Capacity stainless steel: max. 1 mm.

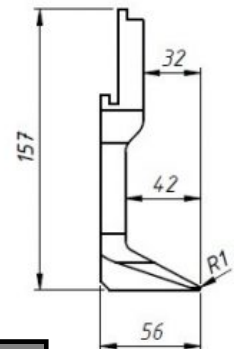
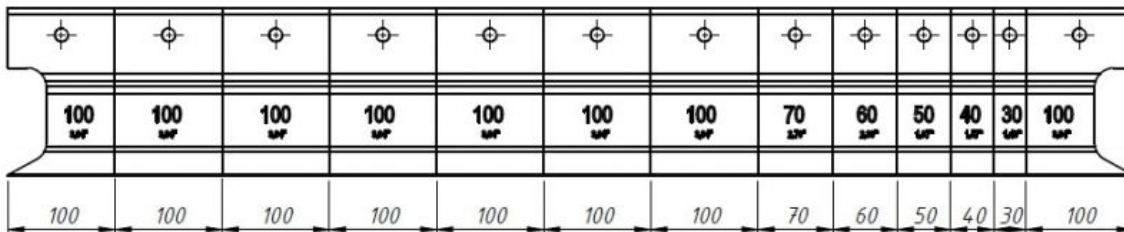

Article no.	Type	Working length	Cap. steel 400 N/mm <sup>2</sup>	Length	Width	Height	Weight
		mm	mm	mm	mm	mm	kg
-	UFA 1015	1050	1,5	1300	750	1515	280
-	UFA 1212	1250	1,25	1500	750	1715	315



# Erbend Folding Machine type UFB

Best  
Quality



**Erbend manual folding machine type UFB** is a solid folding machine with pneumatic support on the folding beam for quick and easy operation.

## Standard equipment:

- 0-150° folding beam
- 45° clamping beam
- Sharp nose blade for clamping beam 20°/R1
- Single piece folding beam tools as 10 or 15 mm and 25 mm (2 sets)
- Folding beam manual adjustment 35 mm
- Clamping beam and folding beam stabilization units
- Bottom beam central support
- Pneumatic pedal support for folding beam (just for folding load assistance not for complete bending)

## Optional:

- 750 mm manual wheel back gauge + sheet support table with gauge arms
- H:60 mm or H:90 mm goat foot segments
- Capacity steel: max. 2.5 mm.
- Capacity aluminum: max. 3.5 mm.
- Capacity stainless steel: max. 1.5 mm.

Article no.	Type	Working length	Cap. steel 400 N/mm <sup>2</sup>	Length	Width	Height	Weight
		mm	mm	mm	mm	mm	kg
-	UFB 1525	1550	2,5	2050	1350	1600	1050
-	UFB 2020	2050	2	2550	1350	1600	1250
-	UFB 2525	2550	1,5	3050	1350	1600	1450
-	UFB 3212	3200	1,2	4050	1350	1600	2150

# Erbend Folding Machine type MFC

Best  
Quality



Erbend CNC motorised folding machine type MFC is a sturdy machine with high speed and high flexibility. You can design and produce your items within a few minutes by means of the user friendly control.

- Capacity steel: max. 2.5 mm • Alu: max. 3.5 mm • Stainless steel: max. 1.5 mm.

## Standard equipment:

- AC motorised Z/Y-axis
- Servo motorised drive of back gauge (X-axis)
- 15,6" touch screen
- CNC control with ERFOLD BASIC software
- Flat rail lower beam tool and feather grooves on backgauge.
- Clamping beam opening height 120 mm (without tools)
- Manual folding beam adjustment 35 mm (A axis)
- 45° clamping beam geometry with single piece 20° sharp nose tool
- Folding beam tools: 7 or 10 or 15 and 25 mm (2 sets)
- 750 mm rectangular back gauge table with ball casters
- 3 switch foot pedal

## Optional:

- 1000-1500 mm mot. back gauge with arms and support table with ball casters
- L or U shaped back gauge with arms and support table with ball casters
- H:60 mm or H:90 mm goat foot segments
- Extra folding beam tools or segment tools
- Manual crowning system
- Motorised folding beam (A-axis)
- Second foot pedal
- Fixed side gauge (squaring arm)
- Rear light barriers
- Erfold ADVANCED 2D and 3D software

Article no.	Type	Working-length	Cap. steel 400 N/mm <sup>2</sup>	Folding angle	Length	Width	Height	Motor clamping Z / folding Y	Weight
		mm	mm	degrees	mm	mm	mm	kW	kg
12501	MFC 2025	2050	2,5	0-135°	3150	1450	1250	1,5 / 2,2	1850
12502	MFC 2520	2550	2	0-135°	3650	1450	1250	1,5 / 2,2	2050
12503	MFC 3215	3200	1,5	0-135°	4150	1450	1250	1,5 / 2,2	2250

# Erbend Folding Machine type MFB

Best  
Quality



Erbend CNC motorised folding machine type MFB is a sturdy machine with high speed and high flexibility. MFB is an extremely versatile folding machine, able to bend different profiles, boxes, etc. by means of various tools, which are easy exchangeable.

You can design and produce your items in a few minutes by means of the user friendly control.

- Folding capacity steel: max. 3 mm / • alu: max. 4 mm / • stainless steel: max. 2 mm

## Standard equipment:

- AC motorised Z/Y-axis
- Servo motorised drive of back gauge (X-axis)
- 15,6" touch screen
- CNC control with ERFOLD BASIC software
- Flat rail lower beam tool and feather grooves on backgauge.
- Clamping beam opening height 160 mm (without tools)
- Manual folding beam adjustment 35 mm (A axis)
- 45° clamping beam geometry with single piece 20° sharp nose tool
- Folding beam tools: 7 or 10 or 15 and 25 mm (2 sets)
- 1000 mm rectangular back gauge table with ball casters
- Led function lights as red, green and blue
- 3 switch foot pedal

## Optional:

- 1500-2500-3000-4000 mm mot. back gauge with arms and support table with ball casters
- L or U shaped back gauge with arms and support table with ball casters
- Vacuum table
- Fixed side gauge on the table
- H:60 mm or H:90 mm goat foot segments
- Goat foot tool pneumatic quick clamping system
- Extra folding beam tools or segment tools
- Manual crowning system
- Motorised folding beam adjustment (A-axis)
- Second foot pedal
- Rear light barriers
- Erfold ADVANCED 2D and 3D software

Article no.	Type	Working length	Cap. steel 400 N/mm <sup>2</sup>	Folding angle	Length	Width	Height	Motor clamping Z / folding Y	Weight
		mm	mm	degrees	mm	mm	mm	kW	kg
12505	MFB 2030	2050	3	0-150°	3050	1600	1350	1,5 / 2,2	2150
12506	MFB 2525	2550	2,5	0-150°	3550	1600	1350	1,5 / 2,2	2400
12507	MFB 3220	3200	2	0-150°	4050	1600	1350	1,5 / 2,2	2650
12508	MFB 4215	4200	1,5	0-150°	4550	1600	1350	1,5 / 2,2	2950

# Erbend Folding Machine type MFD

Best  
Quality



**180° rotating clamping beam  
with 2 tool stations**

Erbend CNC motorised folding machine type MFD is a sturdy machine with high speed and high flexibility with 180° rotating clamping beam with 2 tool stations. MFD is an extremely versatile folding machine, able to bend many different profiles, boxes etc. by means of various tools, which are easy exchangeable. You can design and produce your items in a few minutes by means of the user friendly control.

#### Standard equipment:

- AC motorized drive of clamping, folding, upper beam rotation (Y,Z,C axis)
- Servo motorised drive of back gauge (X-axis)
- COMBI CLAMPING BEAM with 2 tool stations
- 15,6" touch screen
- CNC control with ERFOLD CNC software
- Flat rail lower beam tool and feather grooves
- Clamping beam opening height 160 mm (without tools)
- 100 mm high goat foot tools on station 1
- 20° sharp nose clamping beam tools on station 2
- Folding beam tools as 7 or 10 or 15 and 25 mm (2 sets)
- Manual folding beam adjustment 35 mm (A axis)
- 1000 mm rectangular back gauge table with ball casters
- Led function lights as red, green and blue
- 3 switch foot pedal

#### Optional:

- 1500-2500-3000-4000 mm mot. back gauge with arms and support table with ball casters
- L or U shaped back gauge with arms and support table with ball casters
- Vacuum table
- Fixed side gauge on the table
- Goat foot tool pneumatic quick clamping system
- Extra folding beam tools or segment tools
- Manual crowning system
- Motorised folding beam adjustment (A-axis)
- Second foot pedal
- Rear light barriers
- Erfold ADVANCED 2D and 3D software

Article no.	Type	Working length	Cap. steel 400 N/mm <sup>2</sup>	Folding angle	LxWxH	Weight
		mm	mm	degrees	mm	kg
12509	MFD 2525	2550	2,5	0-150°	3420x2075x2450	5850
12510	MFD 3220	3200	2	0-150°	4430x2080x1875	5500
12511	MFD 4215	4200	1,5	0-150°	4420x2075x2450	7060

# Erbend Folding Machine type MFE

Best  
Quality



**Erbend CNC motorised folding machine type MFE** is a sturdy machine with high speed and high flexibility. MFE is an extremely versatile folding machine, able to bend many different profiles, boxes etc. by means of various tools, which are easy exchangeable. You can design and produce your items in a few minutes by means of the user friendly control.

• Folding capacity steel: max. 5 mm / • Alu: max. 6.5 mm / • Stainless steel: max. 3.5 mm

## Standard equipment:

- AC motorized drive of folding and clamping (Y,Z axis)
- Servo motorized drive of back gauge (X axis)
- Ballscrew spindle system with dual motor drives on clamping and folding
- 15.6" touchscreen
- CNC control with ERFOLD CNC software
- Clamping beam opening height 160 mm (without tools)
- Folding beam tools: 15/ 35 or 25 / 45 mm (2 sets)
- Manual folding beam adjustment 80 mm (A axis)
- 1000 mm back gauge table with ball casters
- Led function lights
- 3 switch foot pedal

## Optional:

- 1500-2500-3000-4000 mm mot. back gauge with arms and support table with ball casters
- L or U shaped back gauge with arms and support table with ball casters
- Vacuum table
- Fixed side gauge on the table
- Manual crowning system
- Motorised folding beam adjustment (A-axis)
- Second foot pedal
- Rear light barriers
- Erfold ADVANCED 2D and 3D software

Article no.	Type	Working length	Cap. steel 400 N/mm <sup>2</sup>	Folding angle	Length	Width	Height	Motor Y / Z / X	Weight
		mm	mm	degrees	mm	mm	mm	kW	kg
-	MFE 2050	2050	5	0-150°	3050	1600	1350	2x3 / 2x5,5 / 0,7	5900
-	MFE 2545	2550	4,5	0-150°	3550	1600	1350	2x3 / 2x5,5 / 0,7	6600
-	MFE 3240	3200	4	0-150°	4050	1600	1350	2x3 / 2x5,5 / 0,7	7400
-	MFE 4230	4200	3	0-150°	4550	1600	1350	2x3 / 2x5,5 / 0,7	8100

# Erbend Folding Machine type MFA

Best  
Quality

180° rotating clamping beam  
with 2 tool stations



Erbend CNC servo combi motorised folding machine type MFA is a sturdy machine with high speed and high flexibility with 180° rotating clamping beam with 2 tool stations. MFA is an extremely versatile folding machine, able to bend many different profiles, boxes etc. by means of various tools, which are easy exchangeable. You can design and produce your items in a few minutes by means of the user friendly control.

## Standard equipment:

- Servo drive of clamping and back gauge ( Z / X axis)
- 15,6" touch screen
- CNC control with ERFOLD CNC software
- AC high torque motorized drive of folding and beam rotation ( Y / C axis)
- COMBI CLAMPING BEAM with 2 tool stations
- Ballscrew spindle system with dual motor drives on clamping and folding
- Clamping beam opening height 250 mm (without tools)
- 120 mm high goat foot tools on station 1
- 30° - R1 sharp nose clamping beam tools on station 2
- Folding beam tools as 10 ,15 or 25 and 35 mm (2 sets)
- Manual folding beam adjustment 80 mm (A axis)
- 1500 mm rectangular back gauge table with ball casters
- Led function lights
- 3 switch foot pedal

- Folding capacity steel: max. 4 mm / Alu: max. 6 mm / Stainless steel: max. 3 mm.

## Optional:

- 2500-3000-4000 mm servo mot. back gauge with arms and support table with ball casters
- L or U shaped back gauge with arms and support table with ball casters
- Vacuum table
- Fixed side gauge on the table
- Goat foot tool pneumatic quick clamping system
- Extra folding beam tools or segment tools
- Manual crowning system
- Servo motorised folding beam adjustment (A-axis)
- Second foot pedal
- Rear light barriers
- Erfold ADVANCED 2D and 3D software

Article no.	Type	Working length	Cap. steel 400 N/mm <sup>2</sup>	Folding angle	LxWxH	Motor clamping Z-axis	Motor clamping rot. C-axis	Motor folding Y-axis	Motor folding adj. A-axis	Weight
		mm	mm	degrees	mm	kW	kW	kW	kW	kg
12512	MFA 2040	2050	4	0-150°	3420x2075x2450	2 x 3	1,5	2 x 3	0,55	5850
12513	MFA 2535	2550	3,5	0-150°	3920x2075x2450	2 x 3	1,5	2 x 3	0,55	6550
12514	MFA 3230	3200	3	0-150°	4420x2075x2450	2 x 3	1,5	2 x 3	0,55	7060
12515	MFA 4225	4200	2,5	0-150°	5420x2075x2450	2 x 3	1,5	2 x 3	0,55	8050

# Erbend Folding Machine type SFA

Best  
Quality



Erbend CNC servo motorised folding machine type SFA is a sturdy machine with high speed and high flexibility. SFA is an extremely versatile folding machine, able to bend many different profiles, boxes, etc. by means of various tools, which are easy exchangeable. Thanks to 350 mm Z-axis stroke and 170 mm high goat foot tools you can make deeper flange, box bendings. You can design and produce your items in a few minutes by means of the user friendly control.

- Folding capacity steel: max. 4 mm / Alu: max. 6 mm / Stainless steel: max. 3 mm

## Standard equipment:

- Servo drive of clamping and back gauge ( Z / X axis)
- AC high torque motorized drive of folding and beam rotation ( Y / C axis)
- Ballscrew spindle system with dual motor drives on clamping and folding
- 15.6" touchscreen
- CNC control with ERFOLD CNC software
- Clamping beam opening height 350 mm (without tools)
- 170 mm high goat foot tools on the clamping beam
- Folding beam tools as 10, 15 or 25 and 35 mm (2 sets)
- Manual folding beam adjustment 80 mm (A axis)
- 1500 mm rectangular back gauge table with ball casters
- Led function lights
- 3 switch foot pedal

## Optional:

- 2500-3000-4000 mm servo mot. back gauge with arms and support table with ball casters
- L or U shaped back gauge with arms and support table with ball casters
- Vacuum table
- Fixed side gauge on the table
- Goat foot tool pneumatic quick clamping system
- Extra folding beam tools or segment tools
- Sharpnose tool
- Manual crowning system
- Servo motorised folding beam adjustment (A-axis)
- Second foot pedal
- Rear light barriers
- Erfold ADVANCED 2D and 3D software

Article no.	Type	Working length	Cap. steel 400 N/mm <sup>2</sup>	Folding angle	LxWxH	Motor clamping Z-/Y-axes	Motor folding A-axis	Motor back gauge X-axis	Weight
		mm	mm	degrees	mm	kW	kW	kW	kg
12520	SFA 2040	2050	4	0-150°	3420x2075x2450	2 x 3	0,55	0,4	5850
12521	SFA 2535	2550	3,5	0-150°	3920x2075x2450	2 x 3	0,55	0,4	6550
12522	SFA 3230	3200	3	0-150°	4420x2075x2450	2 x 3	0,55	0,4	7060
12523	SFA 4225	4200	2.5	0-150°	5420x2075x2450	2 x 3	0,55	0,4	8050

# Erbend mot. Guillotine Shear type EMS

Best  
Quality



Easy programming via ELGO P40T touchscreen digital NC control. In front, the shear is equipped with movable support arms.

**Erbend NC motorised guillotine shear type EMS** is a sturdy machine designed in a very high quality. The shear is characterised by high precision, and is extremely user-friendly and cost effective. Safety is in place both at the front and rear of the machine.

## Standard equipment:

- 750 mm NC servomotor (+/- 0,1 mm accuracy)
- ELGO P40T touchscreen digital NC control
- Back light barriers and finger protection cover in front side.
- Extendable front support table
- Fixed side squaring gauge and stainless feeding table with 500 mm long rulers
- Shadow light and cutting line enlightenment
- Suitable for CE norms

## Options:

- 1000 mm NC motorised back gauge
- Side gauge extension to 2-3 m
- 0-180° angular cutting device
- Pneumatic sheet support system
- Cutting line laser sight
- Blade set as spares
- Wagon with wheels, max. 1000 kg load

Article no.	Type	Working length	Cuts/min.	Motor	Cap. steel 400 N/mm <sup>2</sup>	Capacity stainless	Capacity aluminum	Dimensions LxWxH	Weight
		mm		kW	mm	mm	mm	mm	kg
-	EMS 2030	2100	35	4	3	1,5	4,5	1950 x 2550 x 1600	1510
-	EMS 2040	2100	35	7,5	4	2,5	6	1950 x 2550 x 1600	2500
-	EMS 2525	2550	35	4	2,5	1,5	4	1950 x 3150 x 1600	1690
-	EMS 2540	2550	35	7,5	4	2,5	6	1950 x 3150 x 1600	2700
-	EMS 3220	3200	35	4	2	1,2	3	1950 x 3750 x 1600	2010
-	EMS 3240	3200	35	7,5	4	2,5	6	1950 x 3750 x 1600	3050
-	EMS 4015	4200	35	4	1,5	1	2	1950 x 4750 x 1600	2450
-	EMS 4030	4200	35	7,5	3	2	4	1950 x 4750 x 1600	3500



# Erbend Folding Machines - OPTIONS

Best Quality



Erfold basic CNC control



Erbend 2D / 3D CNC control

ERFOLD ADVANCED cnc graphic software specifically designed for ERBEND motorized folding machines with various solutions and user friendly interface for any kind of folding operation. 15.6" or 22" touchscreen all-in one industrial pc control on swivel arm. 16 GB hard disk space allows you to save unlimited part or tool data.



Goat foot segment 90 mm



Goat foot segment 60 mm



Manual crowning adj.



Dual drive clamping beam with ball screw spindle system for more clamping power



Foot pedal with 3 contacts



Mot. folding beam adjustm.

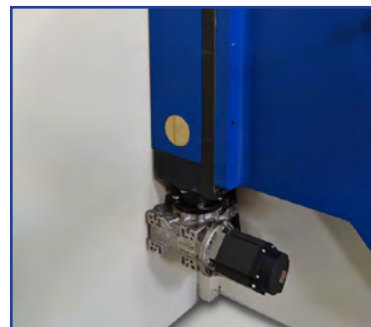

Servo-motorised axis



Solid lower beam tool and feather grooves



Stainless steel back gauge table covers



1500-2000-3000-4000 mm mot. back gauge + support



L-shaped back gauge (metal / brushes)

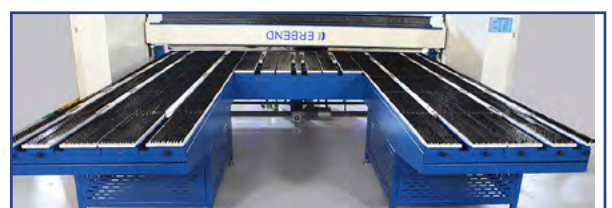

U-shaped back gauge (metal / brushes)

# Plate bending machine - 3 rolls - type MCP

Best  
Quality

Made in  
EU



**The DAVI three roll MCP section roll** was engineered to answer the requirements of very demanding customers, who need to bend parts of large and extra large dimensions with very strict tolerances.

In each sector of applications: from aerospace to shipyard, from automotive to structural, engineers are always proposing solutions of more sophisticated bent parts, made out of hard material that can only be obtained by bending non-standard profiles at very tight diameters with strict tolerances.

Very strong and heavy structures (the heaviest in the market), obtained by using the latest generation of CAD, and tested on FEM software

Three independent hydraulic motors and three high torque planetary drives (one for each roll) are coupled directly to the rolls through a splined shaft, for a powerful torque transmission to ensure an easy feeding of the sections during the rolling phase. The hydraulic traction unit makes it easy to roll I, U and H-beams.

Planetary guide system (patented) of the side rolls are moved by a powerful hydraulic cylinder mounted out of the main machine frame, to run closer to the bending area, avoiding deflection of the shafts.

3D guide rolls, adjustable in three directions are activated by hydraulic cylinders, therefore controlled from the console panel. A standard feature on the complete MCP machine range.

Modular set of rolls are a standard feature and are made out of high tensile strength alloy steel, hardened with very high wearing resistance, designed to perfectly process all standard sections produced in the market.

A very long list of accessories is available, including: hydraulic traction unit, metric wheels for automatic production, special set of guide rolls for non-standard products and many others. These accessories allow the DAVI MCP machine line to bend any kind of standard and non-standard profiles, up to heavy duty beams, pipes and spirals.

# Plate bending machine - 3 rolls - type MAV

Best  
Quality

Made in  
EU  
★★★



**Davi plate bending machine type MAV** is the most advanced plate roller for thickness larger than 40-300 mm. A machine with many exclusive benefits, the best solution available in “super heavy applications”.

Type MAV works like a press brake, where the top roll moves up and down and the material rests on the side rolls like a bed. Opening completely the side rolls, increasing the bed, the machine can form much thicker plates than any other roll in the industry. The side rolls can be moved in and out independently, optimizing the geometry for any application.

## **SERVO-TRONIC**

Servo-Tronic is more accurate than any previous hydraulic, electronic or mechanic (torsion bar) parallel system, and keeps all the three machine's rolls parallel, even in case of electronic problems (less down-time), as it has a dual, independent but integrated, parallel control system (Davi Patent).

## **Roll-by-wire**

Davi has changed the way in which cable routing on the machine is being performed. Unlike other bending machines, where cable routing is tied together through a variety of relays and connectors, Davi has chosen to design the machines in exclusive digital design. The advantages of this are many and include both a reduction of components, more compact design, better precision and higher speed versus normal PLC.

## **Davi advantages**

Permanent Lubrication, Energy Saving, digital Roll by Wire and the dual Servo-Tronic parallel system (most Davi Patented), make it innovative, state-of-the-art, easy to be operated, highly productive, very accurate, reliable and maintenance-free.

## **Tilting of top roll**

The exclusive tilting, self-aligning top roll housing allows, when making cones, to tilt also the top roll up to more than 100 mm, to get easier, faster, more accurate and more angle heavy cones.

# Plate bending machine - 4 rolls - type MCA

Best  
Quality

Made in  
EU  
★★★



**Davi plate bending machine type MCA** is very innovative and exclusive in design, to roll plate up to 4-16 mm thick. Accurate, fast, easy and intuitive, it is the most high-tech plate roll for “light gauge” in the market.. No need to pre-bend the two edges of the plate first, and then roll, as on any three roll. A cylinder can be rolled, including the pre-bending of both ends, feeding the plate forward through the rolls, one time only. Type MCA can be equipped with various CNC-controls, depending on the job to be carried out on the machine.

## **SERVO-TRONIC**

Servo-Tronic is more accurate than any previous hydraulic, electronic or mechanic (torsion bar) parallel system, and keeps the machine’s side rolls parallel, even in case of electronic problems (less down-time), as it has a dual, independent but integrated, parallel control system (Davi Patent).

## **Roll-by-wire**

Davi has changed the way in which cable routing on the machine is being performed. Unlike other bending machines, where cable routing is tied together through a variety of relays and connectors, Davi has chosen to design the machines in exclusive digital design. The advantages of this are many and include both a reduction of components, more compact design, better precision and higher speed versus normal PLC.

## **Davi advantages**

Permanent Lubrication, Energy Saving, digital Roll by Wire and the dual Servo-Tronic parallel system (most Davi Patented), make it innovative, state-of-the-art, easy to be operated, highly productive, very accurate, reliable and maintenance-free.

## **Planetary guides**

It allows for excellent roundness, thanks to the Planetary movement of the side rolls (Davi patent), moving them to the center of the machine (the tightest geometry available).

## **Top bearing housing**

Exclusive DAVI self-adjusting “stress-free” Top bearing housing (tilting). Absorbs any deflection without problems (other brands on the market have rigid, fixed housings, which are affected by the deflection of the top roll).

# Plate bending machine - 4 rolls - type MCB

Best  
Quality

Made in  
EU  
★★★



**Davi plate bending machine type MCB** is the most advanced 4-roll bending machine available, suitable to roll plates from 15-20 mm, up to 20-280 mm thick and more. MCB is the utmost high-tech "high productive mid-heavy application" in the market. A cylinder can be rolled, including the pre-bending of both ends, feeding the plate forward through the rolls, one time only. Type MCA can be equipped with various CNC-controls, depending on the job to be carried out on the machine.

## **SERVO-TRONIC**

Servo-Tronic is more accurate than any previous hydraulic, electronic or mechanic (torsion bar) parallel system, and keeps the machine's side rolls parallel, even in case of electronic problems (less down-time), as it has a dual, independent but integrated, parallel control system (Davi Patent).

## **Roll-by-wire**

Davi has changed the way in which cable routing on the machine is being performed. Unlike other bending machines, where cable routing is tied together through a variety of relays and connectors, Davi has chosen to design the machines in exclusive digital design. The advantages of this are many and include both a reduction of components, more compact design, better precision and higher speed versus normal PLC.

## **Davi advantages**

Permanent Lubrication, Energy Saving, digital Roll by Wire and the dual Servo-Tronic parallel system (most Davi Patented), make it innovative, state-of-the-art, easy to be operated, highly productive, very accurate, reliable and maintenance-free.

## **Planetary guides**

It allows for excellent roundness, thanks to the Planetary movement of the side rolls (Davi patent), moving them to the center of the machine (the tightest geometry available).

## **Top bearing housing**

Exclusive DAVI self-adjusting "stress-free" Top bearing housing (tilting). Absorbs any deflection without problems (other brands on the market have rigid, fixed housings, which are affected by the deflection of the top roll).

# Servo-Electric press brake type C

Best  
Quality

Made in  
EU  
★★★



**CoastOne press brake type Cone** is a new type of servo-electric press brakes, with an ergonomic design which allows the operator to operate the machine sitting. Produced in Finland.

- Digital control unit with touch-screen ( Simple and fast programming )
- Compact design
- Easy to move
- Servo motors with ball-screw spindles
- No hydraulic oil
- Silent operation
- Very low power consumption (1-2 kW)
- Minimal service and maintenance

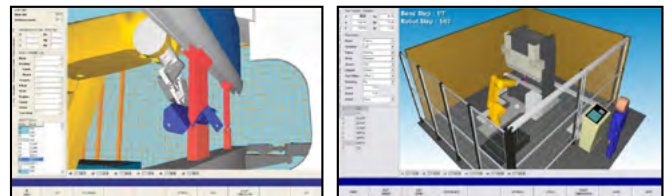

We can also provide CoastOne press brake as a part of a robotic cell.

This cell will be customized in terms of robot-type - offline software and peripherals equipment. Offline software is offered by Robosoft, which makes it possible to create bending programs while programming the robot simultaneously, simple - quickly and efficiently. Suitable for small series.

Art. no.	Type	Cap.	Working length	Stroke length	Opening height	Throat depth	Dist. btw. frames	X-axis	R-Axis	Working speed	Return speed	Motor	Weight
		kN	mm	mm	mm	mm	mm	mm	mm	mm/s	mm/s	kW	kg
C9	220	850	150	500	790	250	400	140	10	100	5	1800	1800
C12	440	1300	150	500	1250	250	600	200	10	100	2 x 5	2800	2800
C15	440	1600	150	500	1550	250	600	200	10	100	2 x 5	3000	2800

# Servo-Electric press brake type Cone

Best  
Quality

Made in  
EU  
★★★



CoastOne machines are equipped as the following:

- X+R at the backgauge
- Promecam or Wila tool clamping - quick tool change
- TC15-20 control unit
- Touch screen
- 250 programs with up to 8 bends each one
- 50 different tool options
- Describe angle, automatic calculation of bending pressure
- Adjustable clearance



The C-series can also be delivered with high opening 650/800 mm, providing multiple opportunities.

All machines are manufactured in accordance with current CE regulations.

- |  |   |  |
|--|---|--|
| <ul style="list-style-type: none"> <li>• 50% off all pieces are less than 1000mm</li> <li>• Most items are less than 3mm</li> <li>• 1 tool is often only necessary</li> <li>• Programs are often very simple</li> <li>• Power consumption is only 1-3 kW</li> <li>• Minimum of floor space is required</li> <li>• Easy to move</li> <li>• Quick and simple to program</li> <li>• Ergonomic working position</li> <li>• Correct working height</li> <li>• Height precision ball screw spindles</li> </ul> | <ul style="list-style-type: none"> <li>• Positioning tolerance <math>\pm 0,005\text{mm}</math></li> <li>• Servo-Electric</li> <li>• No oil</li> <li>• Digital control unit</li> <li>• Promecam/Wila tooling</li> <li>• Quick tool change</li> <li>• Minimal opening at each bend</li> <li>• Increased output</li> <li>• Describe angle - calculate pressure</li> <li>• Adjustable opening</li> <li>• Backgauge with X-R Axes</li> </ul> | <ul style="list-style-type: none"> <li>• Backgauge with pullback</li> <li>• Adjustment of Y-Axis Speed</li> <li>• Ethernet</li> <li>• Userfriendly</li> <li>• 250 programs</li> <li>• 50 tool option</li> <li>• Designed, developed and manufactured in Finland</li> </ul> |
|--|---|--|

# Servo-Electric press brake type Cone G

Best  
Quality

Made in  
EU  
★ ★ ★



CoastOne G-series are bigger models with an O-frame, which means that it is a "closed" frame, thereby avoiding excessive bending in the frame of the machine. Cone G with CNC-controlled crowning guarantees perfect accuracy even in most demanding bendings.

Because of accuracy coming from servo-drives and CNC-crowning, the G-series fits perfectly to small series production.

Tekniske data		G20	G25	G30	G40
Capacity	ton	600	800	1000	1500
Spindles	stk	3	4	5	6
Motor	kw	5	5	5	5
Bending length	mm	2040	2550	3060	4080
Distance between frames	mm	2200	2700	3200	4200
Width	mm/o	2990	3500	4010	5030
Height	mm	2500	2650	2830	2950
Depth	mm	1780	1780	1780	1780
Throat depth	mm	O-frame	O-frame	O-frame	O-frame
Working height	mm	900	900	900	900
Weight	kg	5100	6500	7500	10000
Opening	mm	600	600	600	600
Y / X / R / Z movement	mm	280 / 600 / 200 / 100-3980 0,002 / 0,025 / 0,05 / 0,5 10-100 / 500 / 100 / 1500-2500			
Y / X / R / Z accuracy	+/- mm				
Y / X / R / Z speed	mm/sek				



# Servo-Electric Press Brake type Bull

Best  
Quality

Made in  
EU  
★★★



CoastOne press brake type Bull is a series of electrical press brakes with raw power and ultimate precision. Designed with O-frames, which means a closed frame, thus having less vertical and horizontal deflections. Less weight, better accuracy.

Thanks to the simple drive system, this press brake has a very low power consumption.

- Operation friendly TC programming (simple and quick)
- Ergonomic and compact design
- Works with very high precision
- Servo-motors with ball screws (high precision)
- Average power consumption only 1-3 kW
- Ecofriendly - no hydraulic oil
- Minimum service and maintenance

We can also deliver the CoastOne press brake as a part of a robotic cell.

This cell will be customized in terms of robot-type - offline software and peripherals equipment. Offline software is offered by Robosoft, which makes it possible to create bending programs while programming the robot simultaneously, simple - quickly and efficiently. Suitable for small series.

# Servo-Electric Press Brake type Bull

Best  
Quality

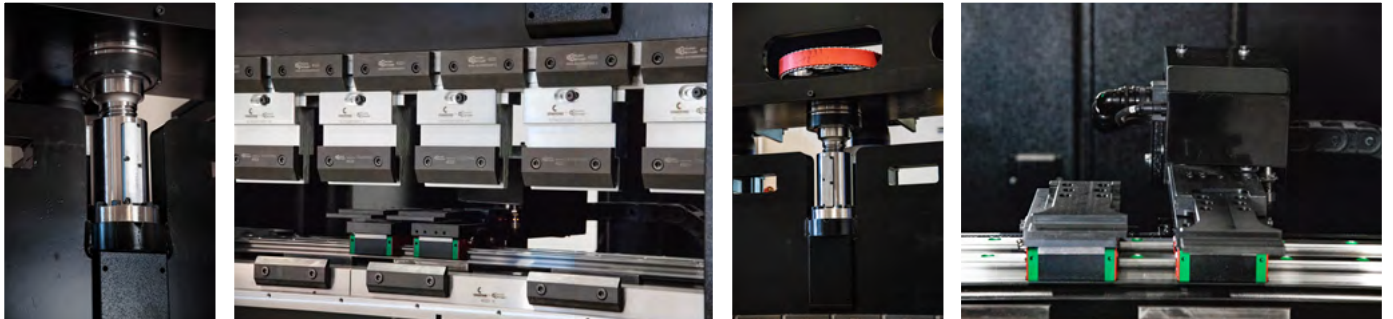

Technical data	Dimensions	Bull 12	Bull 15
Press tonnage	Ton	110	160
Motor	kW	2 x 5	3 x 5
Max. bending length	mm	1320	1620
Distance between side frames	mm	1390	1690
Width	mm	2200	2500
Height	mm	2650	2950
Depth	mm	1760	
Throat depth	mm	O-frame	
Table height	mm	900	
Weight	kg	4500	5500
Gap	mm	600	
Y-axis stroke	mm	250	
Y-axis repeating accuracy	mm	± 0,002	
Y-axis max. working speed	mm/sec.	10 (20)	
Y-axis approach / return speed	mm/sec.	40	
X-axis speed	mm/sec.	500	
X-axis accuracy	mm	± 0,025	
X-axis stroke	mm	600	
X-axis max. positioning dimension	mm	750	
Delta X-axis speed	mm/sec.	100	
Delta X-axis accuracy	mm	± 0,025	
Delta X-axis stroke	mm	± 50	
R-axis speed	mm/sec.	100	
R-axis accuracy	mm	± 0,05	
R-axis stroke	mm	200	
Z-axis speed	mm/sec.	1000	
Z-axis accuracy	mm	± 0,5	
Z-axis stroke	mm	120 to 1100	120 to 1400

# Microcut machining Center type M-Series

Best  
Quality



**MICROCUT** linear way vertical machining centers are powerful and reliable machines with high efficiency and high accuracy in machining performance with a robust and compact structure.

**MICROCUT M series** has four-low linear recirculating ball bearing guideways and a high-precision main spindle with thermal expansion stability. Depending on machining needs, various travel lengths with great capacity satisfy all demands.

The major structural component is made of Meehanite cast iron, which is heat treated to relieve stress, and to assure rigidity and accuracy. All casting is reinforced with heavy ribs to resist vibration. The base incorporates a durable ribbed box design for maximum structural loading.

All structural components and whole machine frame of MM series are analyzed by ANSYS mechanical system and Finite Element Method (FEM) to ensure structural optimization. The triangular wide-distance foundation provides solid support for operation.

## Standard equipment:

- Belt drive spindle 10000 rpm.
- Large fully ground work table with 4 T-slots
- C3 Class precision ground ballscrew.
- Linear guideway
- Fully ground way mating surfaces
- Automatic lubrication with low lubrication fault
- Coolant system
- Telescopic way covers
- Low voltage circuit system
- Chip conveyor
- 4 bar wash down device
- CE standard electrical control system
- Fully enclosure with removable slide door
- Rigid tapping function
- AICC (40 block) for FANUC 0iM
- EMC and safety module
- CE marking declaration conformity for EU
- Heat exchanger

# Microcut machining Center type M-Series

Best  
Quality

## Optional equipment:

- In-line spindle 12000 rpm
- Built-in spindle 14000 rpm
- Spindle oil cooler
- CTS system w.high pressure 20/70 bar pump
- Chip auger
- Air conditioner
- Coolant gun
- Oil skimmer
- 4th axis
- Tool setting probe
- Workpiece probe
- 3 axes with linear scales
- Arm-type ATC with 30T tool capacity



Heidenhain TNC  
620 control



Fanuc 0iM control



Fagor 8055i/8065 control



Siemens Sinumerik  
828D basic control

		M760	M800	M1050	M1200	M1400	M1600
Table size	mm	900 x 410	900 x 520	1200 x 600	1400 x 710	1500 x 600	1700 x 600
Table loading	kg	350	450	800	1000	1000	1200
Travel X-axis	mm	760	800	1050	1200	1400	1600
Travel Y-axis	mm	440	500	600	730	800	850
Travel Z-axis	mm	460	500	600	650	800	850
<b>Belt driven spindle (std)</b>							
Spindle taper		ISO40					
Spindle speed	rpm	10000					
X/Y/Z rapid feed	m/min.	30/30/30					
Guideway type	mm	Linear (ball)		Linear (roller)			
Position accuracy	mm	0,01/300					
Repeatability	mm	±0,01					
Automatic tool changer type		Arm					
No. of tools		24 (standard) / 30 (optional)					
Weight machine	kg	4350	6250	7000	8850	-	-
Floor space (w. chip conveyor)	mm	3400x2000	3838x2300	4320x2300	4250x2600	5200x2700	5200x2700

# Microcut machining Center type C-Series

Best  
Quality



**MICROCUT** linear way vertical machining centers are powerful and reliable machines with high efficiency and high accuracy in machining performance with a robust and compact structure.

High-precision main spindle with thermal expansion stability. Depending on machining needs, various travel lengths with great capacity satisfy all demands.

The major structural component is made of Meehanite cast iron, which is heat treated to relieve stress, and to assure rigidity and accuracy. All casting is reinforced with heavy ribs to resist vibration. The base incorporates a durable ribbed box design for maximum structural loading.

All structural components and whole machine frame of MM series are analyzed by ANSYS mechanical system and Finite Element Method (FEM) to ensure structural optimization.

Extremely precise, high-speed machine with quick-change toolholder, 36 RPM rapid feed.

## Standard equipment:

- Belt driven spindle of 10000 RPM
- 30-tool drum type magazine
- Linear scale for X/Y/Z axes
- Automatic grease lubrication for guideways and ballscrews
- Air through spindle
- Water and air gun
- Oil skimmer
- Wash down system
- Chip conveyor
- 20-bar CTS
- Fully enclosure with removable slide door
- CE-approved

# Microcut machining Center type C-Series

Best  
Quality

## Optional equipment:

- In-line spindle 12000 RPM
- ATC, chain type, 40 tools with loading/unloading station
- CTS 20 bar separate type with paper filter



ATC arm for 40 tools



CTS 20 bar separate type with paper filter

## CNC control:

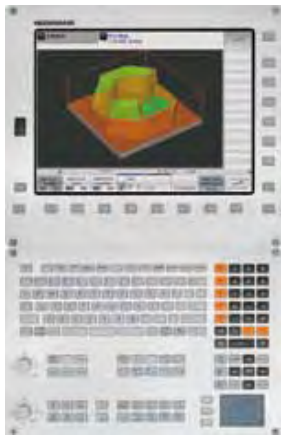

Heidenhain TNC 640 control



10.000 RPM spindle



12.000 RPM in-line spindle

		C1050
Table size	mm	1200 x 600
Table capacity	kg	800
Travel X-axis	mm	1050
Travel Y-axis	mm	600
Travel Z-axis	mm	600
<b>Belt driven spindle (standard)</b>		
Spindle taper		ISO40
Spindle speed	RPM	10000
X/Y/Z rapid feed	m/min.	36/36/36
Guideway type		Linear
Position accuracy	mm	0,008
Repeatability	mm	±0,004
Automatic tool changer type	type	Arm
No. of tools	pcs.	30 (standard) / 40 (option)
Weight machine	kg	7600
Floor space (w. chip conveyor)	mm	2980 x 2622

# Microcut machining Center type VMC-Series

Best  
Quality



VMC-1600



VMC-1300

**MICROCUT** box way vertical machining centers are high-quality machines with maximum productivity and performance and wide applications for molding industry, automobile industry and general workshops.

The machine structure is designed with FMEA to ensure durability and consistency, featuring high level of rigidity and enabling an unsurpassed performance in heavyduty cutting. Structural components are made from Meehanite cast iron, heat-treated to relieve stress thereby assuring max. rigidity and accuracy.

Triangulate wide-stance base incorporates a durable ribbed box design for max. structural loading. All castings are reinforced with heavy ribs to resist flex and damp vibrations. Hardened and precision ground ways on the 3 main axes. Way bearing surface are plated with Turcite B for smooth and stable movement.

## Various features and opportunities for the VMC machining centers:

Pneumatic counter weight - VMC-1100/1300/1600F - Mechanical counter weight - VM-1000/VMC-1600/2100  
Column & saddle - Y-axis guideways - Double-anchored ballscrew - Direct-coupled axes motor - Spindle dynamic balancing - High capacity cartridge spindle - One-piece design headstock - Spindle oil cooler - Geared head for ISO50 taper - Spindle temperature tracing - Chip management - Auxiliary coolant filter

## Controls:

Fanuc 0iMF control (31iMB on request), Fagor 8055 power control, Heidenhain iTNC530 HSCI control, Siemens Sinumerik 828D control

## Standard equipment:

- CNC control
- Z-axis with upgraded motor & built-in brake
- High-speed precision spindle, 10000 rpm/ISO40  
6000 rpm/ISO50 with spindle oil cooler
- Rigid tapping function
- Arm type ATC
- Box sliding way for axes
- Telescopic covers for X & Y axes
- Fully enclosed splash guard w. interlock device
- Enlarged coolant tank and chip pan
- Automatic lubrication system
- Work light
- Portable MPG
- Leveling pads & bolts for installation
- Tool box & kits
- CE marking declaration conformity for EU
- Lamp of cycle finish & alarm
- Heat exchanger

# Microcut machining Center type VMC-Series

Best  
Quality

## Optional equipment:

- Enlarged spindle motor
- Coolant through spindle w. high pressure pump
- Wash down device
- Chip conveyor & bucket
- Air conditioner
- EMC
- 4th axis rotary table
- 4th/5th axis rotary table
- Oil skimmer
- Spindle oil cooler for #40
- Tool setting probe
- Workpiece measuring probe
- Special machine colour on request
- Safety module



VMC-1300 frame

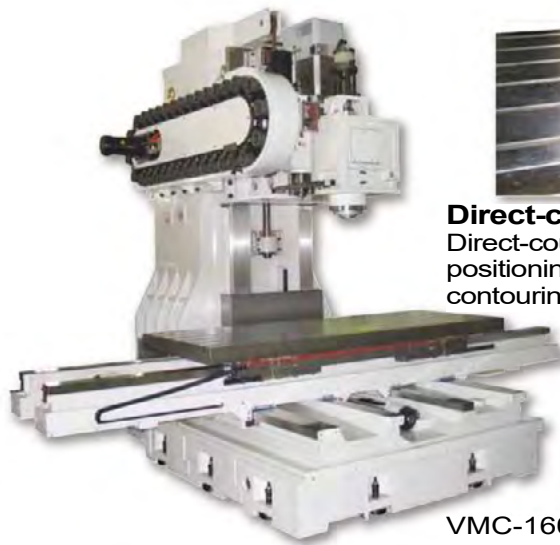

VMC-1600/2100 frame

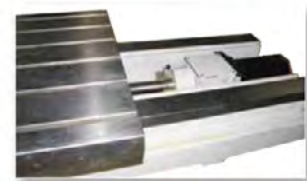

**Direct-coupled axes motors**  
Direct-coupled servo motors improve positioning accuracy and provide better contouring and threading

		VM-1000	VMC-1100	VMC-1300	VMC-1600F	VMC-1600	VMC-2100	VMC-3100
Table size	mm	1300 x 600	1300 x 660	1500 x 660	1800 x 800	1900 x 900	2400 x 900	3400 x 900
Table height	mm	880	880	880	880	1000	1000	1050
Max. table load	kg	800	1200	1200	2000	2000	2500	3000
Travel X-axis	mm	1000	1100	1300	1600	1600	2100	3100
Travel Y-axis	mm	600	710	710	800	900	900	900
Travel Z-axis	mm	600	710	710	710	850	850	850
Spindle taper		ISO40	40/50					
Spindle speed - standard	rpm	10000	10000/6000					
Main motor (conti./30 min)	kW	11/15 (ISO40)			15/18,5 (ISO40)			
X/Y/X rapid feed	m/min.	24/24/24				20/20/18		10/10/10
X/Y/X feed rate	m/min.	10						
Guideway type		Box way						
Position accuracy	mm	0,01/300						
Repeatability	mm	±0,01						
Automatic tool changer type		Arm						
Pocket		24(std)/32(opt)	ISO40: 24T(std)/32T(opt) ISO50:24T(opt)			ISO40:40T/ISO50:32T		
Weight machine #40/#50	kg	5500	7880/8880	8100/9100	10000/11000	20000	22500	30000



# Microcut machining Center type MCU-Series

Best  
Quality



**MICROCUT MCU-5X** is a 5-axis vertical machining center designed for complex and multi surface contour machining. The series has working capacity ideal for medium-size workpiece and offers superior performance in all aspects of milling - consistency, accuracy, and power, therefore serving as a critical asset to all industries. The upgraded gantry type design presents compact structure with maximum working area reserved.

Precise and rigid, the 5-Axis semi-gantry type simultaneous machining center offers high rigidity to endure high-speed and process-intensive machining. Ideal for any complex jobs with various material. All structural components and the whole machine frame of MCU-5X were analyzed by ANSYS mechanical system and Finite Element Method (FEM) to ensure structural optimization.

## Distinctive features:

- Rigid gantry design
- Wide selection of spindles for HSM application
- 15000rpm In-line spindle or high-speed 18000/24000rpm motorized built-in spindle
- AC servo motor provides extremely high torque, power and axis force
- Solid and rigid machine frame made from Meehanite licensed casting
- Collision protection
- Roller type linear guideways on 3 axes
- C3 double-nuts high class precision ballscrews
- Table with high accuracy rotary axis driven by high torque motor
- Maximum table load 600 kg
- High precision encoders on A & C axis
- Side-mounted 24,32,48 or 60 tools ATC for quick tool change if required
- Fully enclosed guarding
- Safety operator protection design
- 4+1 or 5 axes simultaneous machining function
- Automatic grease lubrication timing control & protection
- Ideal chip removal solution
- High pressure coolant system
- Integration of patented technology – Smart Machining Technology (SMT)

## Standard equipment:

- Heidenhain iTNC53 HSCI
- 5 axes simultaneous machining or 5 faces machining
- Coolant through spindle with high-pressure pump 20bar (built-in type)
- Side mounted arm type ATC (24T)
- Central lubrication
- Chip conveyor
- High-pressure chip flush system
- Heat exchanger
- Water gun
- Work light
- Lamp of cycle finish and alarm
- Ethernet
- Tool kit, leveling bolts, pads and nuts
- EMC and safety module for machine
- Portable MPG
- CE marking declaration conformity for EU

# Microcut machining Center type MCU-Series

Best  
Quality

## Optional equipment:

- Linear scale for 3 axes
- Robot for automatic operation
- Reference ball for Kinematic
- Built-in spindle (18000/24000rpm)
- Side mounted arm type ATC (32/48/60T)
- CTS coolant tank (20/70bar)
- Air conditioner for electrical cabinet
- Oil skimmer
- Workpiece setting probe
- Tool setting probe
- EMC filter
- Remote control system



**Angle encoder**  
- High-precision angle encoder fits on A-axis and C-axis.



**Spindles**  
- A wide selection of spindles

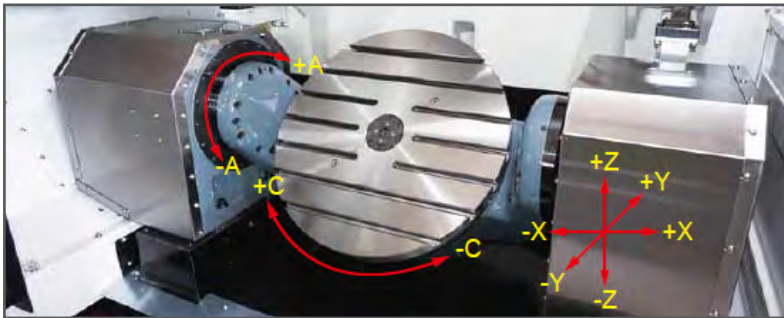

## A-axis

- Provides tilting range of +120 to -120°
- Driven by worm gear with hydraulic brake system providing high torque and excellent durability
- Alternative torque built-in motor as option

## C-axis

- With rotary axis tolerances of  $\pm 5''$
- Driven by high torque built-in motors at 90 rpm with hydraulic brake system providing repeatability accuracy and positioning accuracy

		MCU-5X
Rotary table top diameter	mm	600
Max. table load	kg	600
Linear travel X/Y/Z-axis	mm	600 / 600 / 500
Spindle taper		ISO40
Spindle speed - standard	rpm	15000
Linear guideway X/Y/Z	mm	500 / 1150 / 295
X/Y/X rapid feed	m/min.	36 / 36 / 36
A-axis max. speed	rpm	16,6
C-axis max. speed	rpm	90
Guideway type		Linear way
Position accuracy	mm	0,005
Repeatability	mm	$\pm 0,0025$
Automatic tool changer type		Carousel 24 (std.) / Chain 32/48/60 (opt.)
Max. tool length	mm	300
Max. tool diameter	mm	78
Length x Width x Height	mm	3015 x 5050 x 3000
Weight machine	kg	9000

# Microcut machining Center type TT-Series

Best  
Quality



**MICROCUT** CNC bridge type machining center TT-40 equipped with twin table system, perfect size for mold industries and mass production when using multiple fixture. The machine working program is similar to a pallet changer machine but enhanced with much higher loading capacity and rigidity. With the table combination software and its mechanical loading system, the machine features long table for the multiple applications used in job shops.

Load / unload one table while another table is in working zone which prevent the inherent problems of pallet changers. A safety system is provided. With Fanuc 21iMB or 18iMB control, the two tables can also be combined and work as a big working surface (with 2-servo drive function).

## Distinctive features:

- High-speed spindle available with direct drive spindle
- The spindle is loaded under high precision bearings to ensure a high accurate cutting
- Heavy ribbed throughout for excellent mechanical and thermal stability
- One piece Meehanite base
- All casting have been treated dynamically stress release
- Roller type - 45 give high speed movement and also loading capacity
- C3 double nut high class ballscrew
- Two tables driven by separate ballscrew
- All linear way contact surface scraped to achieve the highest mounting surface
- Well protected guarding system
- Automatic tool changer 24 stations
- Easy chip removal system

## Standard equipment:

- CNC controller and spindle & servo motor package
- 10000rpm spindle speed
- Automatic lubrication systems
- Coolant system
- Halogen work light
- Tool kit, leveling bolts, pads and nuts
- 24 tool arm type ATC
- Fully enclosure splash guard
- RS232 port
- Portable MPG
- Lamp of cycle finish & alarm
- CE marking declaration conformity for EU

# Microcut machining Center type TT-Series

Best  
Quality

## Optional equipment:

- Heidenhain iTNC530 or Siemens 84DE sl control
- Enlarged spindle motor 15/18,5 kW with CTS functions
- Top cover (CTS functions)
- 15000rpm in-line spindle
- Built-in 18000rpm/24000rpm spindle
- Coolant through spindle with high-pressure coolant pump
- 32 or 40 station arm type ATC
- Oil skimmer
- Heat exchanger
- Side door
- Chip conveyor
- Transformer



### Spindle & head

The standard high speed 10000rpm ISO40 taper spindle supported by high precision P5 angular contact spindle bearing.



### Easy chip removal system

The wash down system with high pressure coolant system bring the chips to chip draw (std.) or chip conveyor (opt.).



### ATC

The 24 station (std.) CAM-mechanism type, automatic tool change accepts ISO40 taper tooling. Machine will take long & heavy tools 300 mm. Tool loading is located at rear side of machine convenient for operation load/unload tooling. The 32 or 48 station (opt.) chain type ATC are on request.

		TT-40
Table size - twin table	mm	1000 x 1100
Max. table load	kg	1000
Table travel in work zone X and U axis	mm	2150 / 2190
Saddle travel - Y axis	mm	1100
Head travel - Z axis	mm	750
Spindle taper		ISO40
Spindle speed	rpm	10000 (15000 opt.)
Main motor (conti./30 min)	kW	11/15
X/U/Y/X rapid feed	m/min.	40
X/U/Y/X cutting feed rate	m/min.	10
Guideway type		Linear way (roller)
Automatic tool changer arm type		24 / 32
Max. tool length	mm	300
Max. tool diameter	mm	150
Floor space requirement	mm	6500 x 5000
Weight machine	kg	18000

# Microcut machining Center type DMC-Series

Best  
Quality



**MICROCUT** double column machining center, DMC series combines heavy cutting and high speed machining capabilities in one. Especially excellent for precision machining for extra heavy parts. With the roller type linear guideways on X/Y-axes and box way on Z-axis, the machine fully exhibits its heavy loading resistance and outstanding features.

To meet the high speed and high precision machining requirement, the gearbox also provides high torque output, allowing the machine to perform heavy cutting with ease. The spindle head is designed with advanced automatic compensation balancing system combined with the use of accumulator to control hydraulic cylinder allowing the spindle to move smoothly and steadily at all times.

## Distinctive features:

- Roller type linear guideways on X/Y axes and box way on Z axis
- Three axes are transmitted by class C3 precision ballscrews
- Enclosed splash guard
- Automatic compensated balance system (SCBS) on spindle head
- Automatic lubrication system
- One-piece and box type base
- The beam and the columns are one-piece constructed
- Ladder type slide
- Rigid spindle head
- Lubrication oil and coolant are separately collected
- Extra wide working capacity

## Standard equipment:

- Coolant flushing system
- 3 axes telescopic covers
- Automatic lubrication system
- Working lamp
- Operation status light
- Screw type chip conveyors
- Chain type 32-tool ATC
- Gear head spindle
- Cooling system
- Z-axis pneumatic balance system
- Air gun/water gun
- MPG handwheel
- Heat exchanger
- Spindle oil cooler
- Adjusting tools and box
- Leveling bolts and pads
- Operation and programming manual
- RS-232 Interface
- CE marking declaration conformity for EU

# Microcut machining Center type DMC-Series

Best  
Quality

## Optional equipment:

- Transformer
- Full splash guard
- Chain type chip conveyor
- Coolant through spindle
- Linear scales
- Auto tool length measurement
- Auto workpiece measurement
- Manual universal head (90 degr.)
- Auto universal head (90 degr.)
- Rotary table
- Safety module for all types of controller



Individual coolant tank

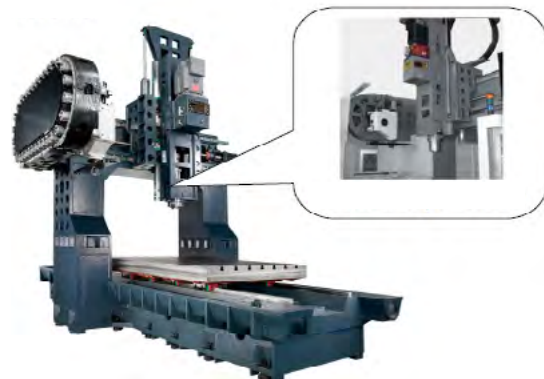

Transformer



Chip conveyor

Double column machining center		DMC-A				DMC-B			DMC-C		
		1700A	2200A	3200A	4200A	2200B	3200B	4200B	2200C	3200C	4200C
Table size	mm	1700x1200	2200x1200	3200x1200	4200x1200	2200x1500	3200x1500	4200x1500	2200x1700	3200x1700	4200x1700
Max. table load	kg	5000	5000	8000	8000	5000	8000	8000	8000	10000	12000
Travel X-axis (linear)	mm	1700	2200	3200	4200	2200	3200	4200	2200	3200	4200
Travel Y-axis (linear)	mm	1400				1700			1900		
Travel Z-axis (box)	mm	850				850			850		
Spindle taper		ISO 50				ISO 50			ISO 50		
Spindle speed	rpm	8000				8000			8000		
Main motor	kW	15 / 18,5 (Fanuc)				15 / 18,5 (Fanuc)			15 / 18,5 (Fanuc)		
X/U/Y/X rapid feed	m/min.	20/20/20	16/20/20	16/20/20	12/20/20	16/16/20	16/16/20	12/16/20	12/16/20	12/16/20	10/16/20
X/U/Y/X cutting feed rate	m/min.	10/10/10				10/10/10			10/10/10		
ATC		Chain type - arm				Chain type - arm			Chain type - arm		
Tool storage capacity	Pcs.	32 / 40 (opt.)				32 / 40 (opt.)			32 / 40 (opt.)		
Max. tool length	mm	350				350			350		
Floor space (LxW)	mm	5800x4150	6090x4150	8130x4150	10310x4150	6090x5300	8130x5300	10310x5300	6090x5300	8130x5300	10310x5300
Weight machine	kg	15500	16000	17000	18000	21000	22500	24000	22000	23500	25000

# Microcut machining Center type HM-Series

Best  
Quality



**MICROCUT** horizontal machining center HM-6300 with Fanuc 32iB control, is a T type column moving horizontal machining center providing ISO50 BBT spindle taper with 6000rpm spindle speed and auto 3-step speed changer for high torque throughout within a speed range by automatic control, and 40 tools ATC. In addition the high rigidity and stability of its construction offer customers the maximum productivity and the best profit.

HM is ideal for all kinds of industries, e.g. die and mold, oil and gas, shipbuilding, automotive and aerospace industries.

## Distinctive features:

- Rigid spindle with 6000rpm, BBT50 spindle tooling and 3-step speed changer at high speed output
- Extremely large working capacity with table loading capacity
- AC servo motor provides extremely high torque, power and axis force
- Meehanite cast iron construction provides excellent mechanical stability
- Box guideway with hardened and ground X/Y/Z axes offer rigid and rapid feed
- High precision C3 class hollow shaft ballscrew with double nuts
- High indexing accuracy rotary table; 0.001 degree rotary table is available
- Linear scales on axes and angle encoder on B axis give absolute positioning accuracy

## Standard equipment:

- CNC control and spindle & servo motor package
- Ground work table with 5 T-slots
- Precision ground ballscrew
- Heavily ribbed cast iron components
- ISO 50 BBT spindle
- Automatic central lubrication
- Coolant system
- Chip drawers
- Telescopic way covers
- Low voltage circuit system
- 1.2 T table loading
- Spindle oil cooler
- Automatic tool changer 40T
- Chip auger
- Hollow ballscrew with oil cooling system for X/Y/Z axes
- Portable MPG
- Reservation for coolant through spindle oil system
- Automatic power off device
- Automatic two pallet changer
- Oil tank
- Fully enclosed guard with working light
- CE marking declaration conformity for EU

# Microcut machining Center type HM-Series

Best  
Quality

## Optional equipment:

- Tool changer (ATC) 60 tools
- Single working table
- Encoder for 3 axes
- CTS system with 20/70 high pressure pump
- Water gun
- Spray cooling on top
- Chip conveyor
- Workpiece probe
- Tool probe
- Oil skimmer
- Air conditioner



Renishaw RTS tool probe



Workpiece probe



Linear scale for X/Y/Z axis



Oil skimmer



Chip conveyor

		HM-6300
Table size	mm	630 x 630
Max. table load	kg	1200 x 2
Travel X axis	mm	1050
Travel Y axis	mm	1100
Travel Z axis	mm	750
B axis index	degr	1/0.001 (opt)
Spindle taper		ISO 50 (7:24) / BBT 50
Spindle speed	rpm	6000
Transmission		Gear box
Spindle step		3 steps (auto)
Guideway type		Box way
Automatic tool changer - tool capacity		40 / 60(opt.)
Max. tool length	mm	610
Weight machine	kg	21000



# Microcut CNC slant bed lathes HT-Series

Best  
Quality



**MICROCUT HT/HTL series and HTY/HTLY series slant bed lathes** offer large swing capacity with maximum cutting diameter 450mm and cutting length 1,250mm. The one-piece 45° slant casting bed ensures the rigidity of machine structure for heavy loading. Numerous optional accessories are selectable to meet the demands of various industries, including automotive, medical, educational, and general machining shops.

## Distinctive features:

- Wide selections of spindle bar
- Heavy workpiece loading
- Optimized headstock design for easy heat dissipation
- One-piece rigid design with 45° slant bed
- Hydraulic oil pressure detection device and anti-oil leakage monitoring system
- 8 or 12 position hydraulic turret with fast indexing
- Tailstock rapid positioning driven by saddle
- Programmable tailstock and quill movement
- Large and concise machining room ensures easy chip cleaning
- Full CNC package including controls and motors
- Automatic door with anti-tripping detecting system provides safety working environment

## Standard equipment:

- The availability of CNC controls: Fagor 8055i/FL, Fanuc Oi with manual guide Oi, Siemens 828D basic
- 8-position hydraulic turret, regular type
- Hydraulic 3-jaw chuck w/hard jaws
- High pressure coolant system
- Auto lubrication system
- Work lamp
- Hydraulic unit
- Programmable tailstock
- Fully enclosed splash guard w/interlock safety device
- Auto lock/unlock door
- Tool set & box, level pads
- CE marking declaration of conformity for EU
- Heat exchanger integrated with electric cabinet

# Microcut CNC slant bed lathes HT-Series

Best  
Quality

## Optional equipment:

- Soft jaw for 8"/10"/12" chuck
- Tool holder package for standard (regular) turret
- Bigger hydraulic chuck
- Collet unit
- Various sizes of collets
- C axis
- Power turret
- Live tool holders
- Auto parts catcher w/parts catcher box
- Renishaw tool setter
- Bar feeder and interface
- EMC
- Oil skimmer
- 20 bar coolant through spindle



92HTY

		52HT/HTL	52HTY/HTLY	76HT/HTL	76HTY/HTLY	92HT/HTL	92HTY/HTLY
Swing over bed	mm	600	700	600	700	600	700
Max. cutting dia. with turret	mm	580	400/385	580	400/385	580	400/385
Max. cutting length	mm	750/1250					
Travel X-axis	mm	305	275 (axial)	305	275 (axial)	305	275 (axial)
Travel Y-axis	mm	-	±55	-	±55	-	±55
Travel Z-axis	mm	750/1250					
Spindle speed	rpm	4500	4500	3000	3000	2500	2500
Bar capacity	mm	51	51	76	76	92	90
Chuck size	mm	200	200	250	250	305	305
Spindle main power	kW	Fagor 12/18 Fanuc 11/15 Siemens 17/22	Fagor 12/18,5 Fanuc 11/15 Siemens 17/25,5	Fagor 17/25 Fanuc 15/18,5 Siemens 30/45	Fagor 17/25 Fanuc 15/18,5 Siemens 30/45	Fagor 22/33 Fanuc 18,5/22 Siemens 28/42	Fagor 22/33 Fanuc 18,5/22 Siemens 28/42
Rapid feed (X&Z)	m/min.	24/24					
Rapid feed (Y)	m/min.	-	7,5	-	7,5	-	7,5
Tailstock travel	mm	600					
Quill travel	mm	120					
Machine weight	kg	5400	7600/8600	5500/6500	7600/8600	5700/7200	7600/8600

# Microcut CNC slant bed lathe 117HT

Best  
Quality



**MICROCUT 117HT** is the large slant bed lathe with 18" hydraulic chuck and 117mm bar capacity, 1.3~3.8M cutting length and 700mm turning diameter. The model is suitable for wide applications in various industries such as automobile, energy, aerospace and general machining shops. Providing with greater speed, powerful cutting, accuracy machining and durability over competitors, 117HT can make the highest possible return on investment.

117HT is equipped with a fast turret which provides quick rotation time for the bidirectional 12-station hydraulic turret along with a programmable tailstock as the standard accessory. Living tool, C-axis, bar feeder, chip conveyor, and parts catcher, all are available for complex parts and automatic production.

## Distinctive features:

- One-piece rigid design with 45 degr. slant bed
- Large bar capacity of 117 mm
- All-box-way structure
- Short distance between guarding and center line
- 2137 kg of Z-axis thrust
- 18" hydraulic 3-jaw chuck
- 12 position hydraulic turret
- High tool indexing accuracy and fast tool change
- Programmable tailstock
- Enhanced chip flush device
- Anti-oil-leakage lubrication monitoring system
- Support Y axis (opt.) and C axis (opt.) machining

## Standard equipment:

- Fanuc 0iTD control with 10,4" LCD monitor with manual guide i
- 12 position hydraulic turret, regular type
- Tool holder package
- 18" hydraulic 3-jaw chuck with hard jaws
- High-pressure cooling system
- Automatic lubrication system
- Work lamp
- Hydraulic unit
- Programmable tailstock
- Fully enclosed splash guard w. interlock safety device
- CE marking declaration conformity for EU
- Chip conveyor without bucket
- Heat exchanger for electric cabinet

# Microcut CNC slant bed lathe 117HT

Best  
Quality

## Optional equipment:

- C- and Y-axis
- Renishaw tool setter (aut./ man.)
- Power turret
- Live tool holders
- Spindle reduction tube
- Current leakage detector
- Enlarged chuck
- Soft jaw
- Chip bucket
- Power transformer
- Air conditioner f. electric cabinet
- Safety module
- EMC
- 5 or 20 bar high pressure coolant pump
- Hydraulic steady rest
- Bar feeder and interface
- Automatic parts catcher
- Oil skimmer
- Automatic door

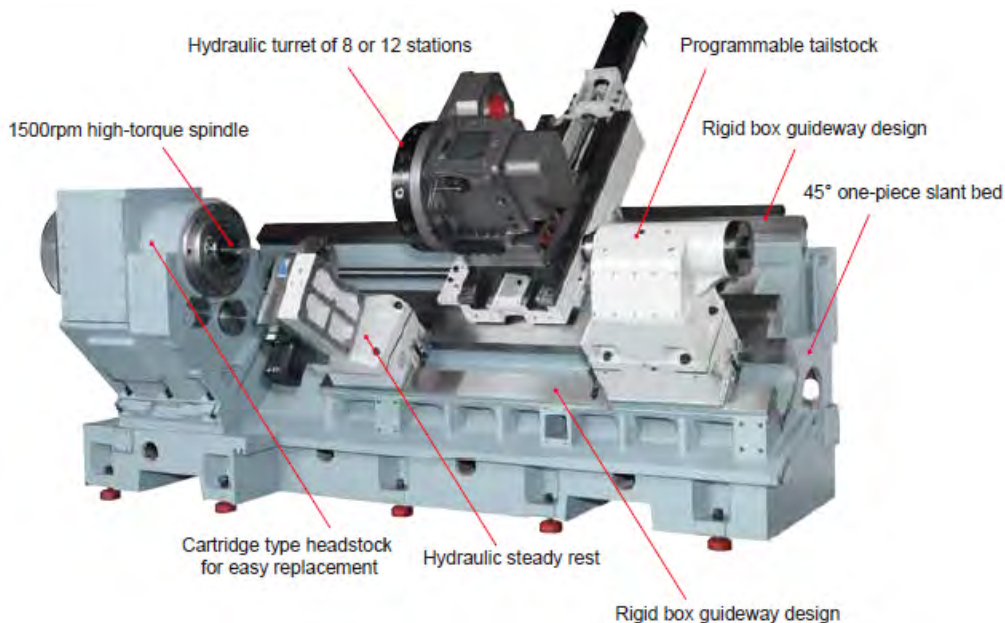

Fanuc 0iTD control



Guideway - box-way structure



Hydraulic 3-jaw 18" chuck as standard or 20" chuck as option

		117HT
Swing over bed	mm	900
Max. cutting dia. with turret	mm	700
Max. cutting length	mm	1300/2050/2800/3800
Travel X-axis	mm	385
Travel Y-axis	mm	100 (±50)
Travel Z-axis	mm	1500/2250/3000/4000
Spindle speed	rpm	1500
Bar capacity	mm	117
Chuck size	mm	450
Spindle main power	kW	30/37 (40/50 HP)
Rapid feed (X/Y/Z)	m/min.	20/20/20
X / Z axis servo motor	kW	4/7 (5,4/9,4 HP)
Tailstock travel	mm	1300/2050/2800/3800
Quill travel	mm	150
Machine weight	kg	7600/8600

# Microcut CNC slant bed lathes LD-series

Best  
Quality



**MICROCUT twin spindle single turret slant bed CNC lathe type LD** is capable of multi-axis turning and milling. Besides twin spindles the machine has single turret, live tooling, C-axis, Y-axis and is capable of producing high accuracy parts.

The tool setter and workpiece probe and accessories allow further setup for automated operation to reduce intensive labor costs. Complex machining in one-setup, but is also ideal for tasks requiring long time loading. It highly increases efficiency and productivity, and meets the diversified tasking requirement of production.

## Distinctive features:

- Twin spindle single turret
- Reliable and rapid turret indexing
- Reducing idle time
- Apply all processes on one machine
- Increase the productivity
- Milling and turning in one setup
- 30° one-piece slant bed for rigid structure
- Reducing frequency of loading & unloading
- Linear way ensures faster movement
- 8" and 10" hydraulic chuck
- Strategic ribbed bed for max. stiffness
- Headstock design with optimal heat dissipation
- Ready for automation

## Standard equipment:

- Fanuc 0iTF with 8,4" LCD manual guide 0i
- Main spindle motor 11/15 kW
- Auxiliary spindle motor 7,5/11 kW
- C axis with braking system
- Power turret, 12 station, BMT55 5 tooling
- Foot switch for chuck operation
- Auto lubrication system
- Work lamp
- M30 program stop light
- Hydraulic unit
- Fully enclosed splash guard w. interlock safety device
- CE marking declaration conformity for EU
- Tool set & box & level pads
- Heat exchanger for electric cabinet

# Microcut CNC slant bed lathes LD-series

Best  
Quality

## Optional equipment:

- Fanuc 0iTF control with 10,4" LCD display and Manual Guide i
- C-, C2- and Y-axis
- Oil skimmer
- Chip conveyor
- 12 station hydraulic turret
- 12 station VDI30/40 turret, VDI30 power & VDI30 servo power turret
- 10" hydraulic 3-jaw chuck for LD-65 primary spindle
- Air conditioner
- Hydraulic collet chuck
- Tool probe
- Coolant through tool system
- Bar feeder
- Parts catcher



Fanuc 0iTF control with 10,4" LCD display and Manual Guide i

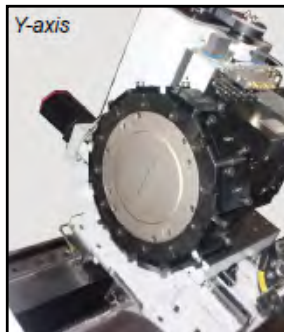

Y-axis enables diverse and off-center machining for complicated parts

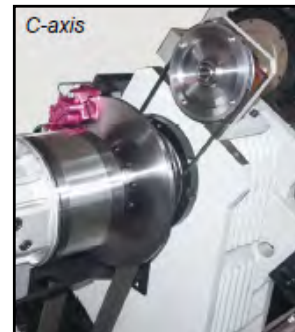

C-axis with braking system provides spindle angle indexing & superior performance

		LD-52	LD-65
Swing over bed	mm	650	
Swing over cross slide	mm	380	
Max. cutting dia. with turret	mm	380	
Max. cutting length	mm	520 / 1020	
Travel X-axis	mm	215 (200+15)	
Travel Y-axis (option)	mm	100 (±50)	
Travel Z-axis	mm	520 / 1020	
Travel Z2 axis	mm	520 / 1020	
Spindle speed primary spindle	rpm	5000	4000
Spindle speed second spindle	rpm	5000	
Bar capacity	mm	Ø52	Ø65
Rapid feed X / Z / Z2	m/min.	24/24/24	
Rapid feed Y (option)	m/min.	6	
X / Z / Z2 axis servo motor	Nm	8	
Y axis servo motor (option)	Nm	4	
Positioning accuracy	mm	0,01/300	
Repeatability accuracy	mm	±0,01	
LxWxH (w/o chip conveyor)	mm	3500 x 3135 x 1950	4020 x 3135 x 1950
LxWxH (w/chip conveyor)	mm	3985 x 3135 x 1950	4485 x 3135 x 1950

# Microcut CNC slant bed lathes LT-series

Best  
Quality



**MICROCUT CNC slant bed lathe type LT** offers an exceptional combination of standard features in a rugged, affordable package. This machine has greater speed, power, accuracy and durability. The LT-series features an 11 kW spindle drive (Fanuc) and includes a high quality 3-jaw power chuck as standard equipment.

A fast turret with 12 or 8 stations provides quick rotation time of 0,79 sec. to adjacent station. Living tool, C-axis and parts catcher are available for complex parts and automatic production.

## Distinctive features:

- One-piece 30° slanted bed
- Linear way ensures faster movement
- Higher spindle speed & heat dissipation
- Easy chip removal
- Mechanical hydraulic chuck interface
- Oil leakage detection device
- Hydraulic oil pressure detection device
- Waste oil / coolant separator
- Chip conveyor can easily be retrofitted
- Laser calibration on X- & Z-axes
- Wide selection of tooling system available
- Rigid linear guideways provides max. static and dynamic stiffness
- Double-nut, hardened & ground ballscrew for added stiffness and rigidity
- Encoder is built into each motor for precision accuracy
- Direct drive on each axis

## Standard equipment:

- Fanuc control - Manual Guide programming
- Hydraulic tailstock quill
- Hydraulic 3-jaw chuck (including soft & hard jaws)
- High-pressure coolant system
- Auto lubrication system
- Hydraulic unit
- Fully enclosed splash guard with interlock safety device
- CE marking declaration conformity for EU
- Heat exchanger for electric cabinet

# Microcut CNC slant bed lathes LT-series

Best  
Quality

## Optional equipment:

- Manual / automatic tool setter
- C axis with braking system
- Extra tool holder set or VDI tool holder set
- Auto parts catcher
- Bar feeder interface
- Bar feeder V-65E / V-65LE / DH-65
- Spindle reduction tube (45 mm) for bar feeder
- EMC
- Collet unit & collet
- Fanuc 0iTF control with 10,4" LCD display and Manual Guide
- Auto open/close door
- Chip conveyor
- Chip bucket
- Power transformer
- Live tool holders
- 20 bar high-pressure coolant pump



Standard equipped with hydraulic 3-jaw chuck



Chip conveyor can easily be retrofitted



		LT-42	LT-52	LT-65
Swing over bed	mm	500		
Swing over cross slide	mm	220		
Max. cutting dia. with turret	mm	210		
Max. cutting length	mm	460		
Travel X-axis	mm	215 (170+45)		
Travel Z-axis	mm	520		
Spindle speed	rpm	6000	5000	4000
Bar capacity	mm	42	52	65
Chuck size	mm	169	210	215
Rapid feed X / Z	m/min.	30/30		
Main motor	kW	11/15 Fanuc 7,5/11 Fagor 12/15 Siemens		
X axis servo motor	kW	1,8		
Z axis servo motor	kW	1,8		
Positioning accuracy	mm	±0,005/300		
Repeatability accuracy	mm	0,005		
Weight	kg	3000	3040	3070



# Microcut CNC flat bed lathes BNC-1600/1800

Best  
Quality



**BNC-1800 flat bed lathe**

**MICROCUT's CNC Lathe BNC-1600 / 1800 series** is specially designed for the best cutting performance, high removable rate, and great capability for turning medium size workpieces. All bearing surfaces are coated with low friction material, allowing all axes movement under minimum friction. The rigid box guideway design offers high rigidity, accuracy, durability, fast rapid feed and cutting feed as well as large loading capacity.

BNC 1600 is with a single high speed of 5000 rpm, BNC 1800 is built with automatic spindle speed changer mechanical hydraulic chuck interface.

## Distinctive features:

- High spindle speed and torque
- Extra wide bed and box way design ensures machine stability
- Faster rapid feed rate of 15 m/min. for X/Z axes
- Long cutting length
- Gap bed for big disc turning
- Machine standard equipped with QCT, prepared for turret to be mounted in rear side of cross slide
- Excellent chip disposal design
- User-friendly operation station
- Large windows and full opening of doors
- Easy retrofit chip conveyor
- Heavy loading tailstock
- Thread repair function

## Standard equipment:

- CNC control Fagor 8055 iFL
- Quick change tool post
- Chuck sliding guard with interlock device
- Gap bed
- Tailstock
- Fully enclosed front guarding with interlock system
- Coolant system
- Lubrication system
- CE marking declaration conformity for EU
- Leveling pads
- Tool set & kits
- Heat exchanger

# Microcut CNC flat bed lathes BNC-1600/1800

Best  
Quality

## Optional equipment:

- 11/15 kW spindle motor
- Turret (hydraulic or electric)
- Manual 3-jaw chuck
- Roller steady rest 20-200 mm
- Hydraulic steady rest preparation
- Follow rest 20-200 mm
- Tailstock interlock system
- Hydr. tailstock quill
- Air lifting for tailstock
- Tailstock end cover with limit switch
- Chip conveyor + wash down system
- EMC
- Portable MPG
- Transformer
- Tool holders
- Available controls:  
Fagor 8055 iFL 10,4" LCD full key control, Fanuc 0iTD with Manual Guide i or Siemens 828D basic



Fagor 8055 iFL  
Standard



Fanuc 0iTD w/Manual  
Guide i



Siemens 828D basic

		BNC-1600	BNC-1800
Swing in gap	mm	660	710
Swing over bed	mm	425	475
Swing over cross slide	mm	190	240
Max. cutting length with turret	mm	1000 / 1500	
Bar capacity	mm	37	44 (6"chuck) / 51 (8-10" chuck)
Travel X-axis	mm	260	
Travel Z-axis	mm	1180 / 1680	
Rapid traverse X & Z	m/min.	15 & 15	
Spindle bore	mm	Ø46	Ø65
Spindle speed	rpm	0-5000	0-4500
Spindle motor	kW	7,5/11 (11/15 Fanuc)	
Guideway X-axis	mm	215	
Guideway Z-axis	mm	355	
Quill stroke	mm	150	
Quill diameter	mm	65	80
LxWxH (w/o chip conveyor)	mm	3030x1952x2022	3530x1952x2022
LxWxH (w/chip conveyor)	mm	4177x1952x2022	4677x1952x2022
Weight	kg	2400 / 2850	3000 / 3450

# Microcut CNC flat bed lathes BNC-2200/2600

Best  
Quality



**BNC-2200 flat bed lathe**

**MICROCUT's CNC Lathe BNC-2200 / 2600 series** is specially designed for the best cutting performance, high removable rate, and great capability for turning medium size workpieces. All bearing surfaces are coated with low friction material, allowing all axes movement under minimum friction. The rigid box guideway design offers high rigidity, accuracy, durability, fast rapid feed and cutting feed as well as large loading capacity.

The lathe features a 2-step automatic transmission gear box with wide range torque output and complete automatic turning program.

## **Distinctive features:**

- High spindle speed and torque
- Various spindle bore available
- Automatic spindle speed changer
- Mechanical hydraulic chuck interface
- Extra wide bed and box way design
- Gap bed for big disc turning
- Machine standard equipped with QCT, prepared for turret to be mounted in rear side of cross slide
- Extra wide cross slide
- Turcite B coated on all bearing ways
- Lubrication monitoring system
- Easy retrofit chip conveyor
- User-friendly operation station
- Complete CNC control package
- Heavy loading tailstock
- Thread repair function

## **Standard equipment:**

- CNC control Fagor 8055 FL
- Quick change tool post
- Automatic speed changer
- Chuck sliding guard with interlock device
- Gap bed
- Tailstock (interlock device for 3M & 4M)
- Fully enclosed front guarding with interlock system for center length 40"/60"/80"
- Traveling front single door with interlock safety device for center length 120"/160"
- Coolant system
- Lubrication system
- CE marking declaration conformity for EU
- Leveling pads
- Tool set & kits

# Microcut CNC flat bed lathes BNC-2200/2600

Best  
Quality

## Optional equipment:

- 15/22 kW spindle motor
- Cam lock D1-8 spindle bore for 82/106 mm spindle
- 3-jaw chuck (man., hydr. or pneumatic)
- 4-jaw manual chuck
- Turret (hydr. or electr.)
- Power turret
- Electric 4-way tool post
- Boring bar base/holder
- C- / Y-axis
- Rear chuck mounting preparation
- Rear chuck guard
- Roller steady rest 20-200 mm
- Roller steady rest 150-300 mm
- Hydraulic steady rest preparation
- Follow rest 20-200 mm
- Enlarged 100 mm tailstock quill
- Hydr. tailstock quill
- Tailstock end cover with limit switch
- Fully enclosed guarding for 120"/160" length
- Chip conveyor + wash down system
- EMC
- Portable MPG
- Transformer
- Tool holders
- Available controls:  
Fagor 8055A TC, 8055A FL & Power or Fanuc 0iTD or Siemens 8089 basic



Large tailstock ideal for heavy workpieces. Interference-free.



BNC-2260X with open door.

		BNC-2200	BNC-2600
Swing in gap	mm	790	870
Swing over bed	mm	550	650
Swing over cross slide	mm	310	410
Max. cutting length with turret	mm	1000 / 1500 / 2000 / 3000 / 4000	
Travel X-axis	mm	345	
Travel Z-axis	mm	1150 / 1650 / 2150 / 3150 / 4150	
Rapid feed X-axis	m/min.	15 (up to 2 M) / 12 (3M & 4M)	15
Rapid feed Z-axis	m/min.	15 (up to 2 M) / 12 (3M & 4M)	15 (up to 2 M) / 12 (3M & 4M)
Rapid feed Y-axis (opt.)	m/min.	-	7,5
Spindle bore	mm	82 (std.) / 106 (opt.)	82 (std.) / 106/153 (opt.)
Spindle speed	rpm	80-3500 (82mm) 80-2400 (106mm)	80-1480 (153mm)
Spindle motor	kW	11/15 (up to 2M) / 15/22 (3M & 4M)	15 (up to 2M) / 12 (3M & 4M)
X-axis guideway type		Dovetail	
Z-axis guideway type		Box way	
Y-axis guideway type		Box way	
Quill stroke	mm	150	
Quill diameter	mm	65	80
Weight	kg	4300 (BNC-2260+2660) / 5800 (BNC-22120+26120)	

# Microcut heavy duty CNC lathe BNC-2800A

Best  
Quality

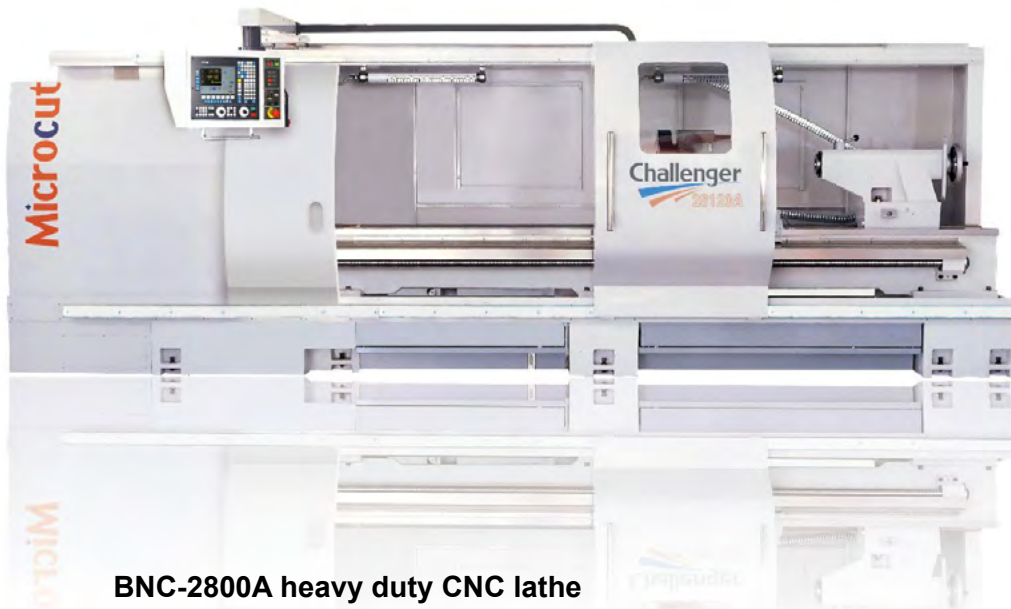

BNC-2800A heavy duty CNC lathe

**MICROCUT's heavy duty CNC lathe BNC-2800A series** is specially designed for heavy duty cutting with longer Z travel for full size cutting capacity. Powerful geared headstock with automatic speed changer provides high torque output. Moreover, the wide range of Z travel length is selectable to customize various machining demands.

The one-piece casting bed is Meehanite licensed casting, and this rigid structure assures vibration-free and prevents deformation. The double box way is designed for rapid traverse in extremely wide bed to carry the heavy workpiece. The ballscrew is pre-loaded to ensure position and repeatability accuracy. Gap bed design enables the turning of big diameter parts.

## Distinctive features:

- User-friendly swivel control panel & eye-level monitor position
- Single door interlocked with carriage for extra protection
- Enlarged window for better visibility
- Longer tailstock design is ideal for carrying the heavy workpiece
- Hydraulic tailstock quill enables the operator to easily load/unload the long workpiece
- The longer quill ensures the full length machining
- Thread repair function
- Long gap bed for disc turning
- Machine offers full Z-cutting capacity
- NN bearings for 6" bore spindle support
- Turcite B with all bearing surfaces

## Standard equipment:

- Fagor 8055i FL CNC control
- Gear head
- Automatic speed changer
- Chuck sliding guard with interlock device
- Gap bed
- Tailstock
- Travelling front single door
- Coolant system
- Lubrication system
- Portable MPG
- Heat exchanger
- CE marking declaration conformity for EU
- Leveling pads
- Tool set & kits

# Microcut heavy duty CNC lathe BNC-2800A

Best  
Quality

## Optional equipment:

- Quick change tool post
- Turret (hydraulic or electric) & power turret
- Boring/bar base holder
- C-axis
- 5 bar coolant system
- 20 bar coolant through tool
- Rear chuck mounting preparation
- Rear chuck guard
- Manual & hydr. 3-jaw chuck
- Independent manual 4-jaw chuck
- Automatic bar feeder
- Roller steady rest 50-300 mm & 250-380 mm
- Hydraulic steady rest preparation
- Follow rest 20-200 mm
- Hydr. tailstock quill & rotating tailstock quill
- Tailstock end cover with limit switch
- Full enclosure guarding
- Chip conveyor + wash down system
- Oil skimmer
- EMC
- Transformer
- Tool holders
- Available controls:  
Fagor 8055i FL, Fanuc 0iTD with Manual Guide or Siemens 828D basic

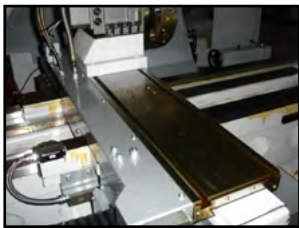

Extra wide cross slide

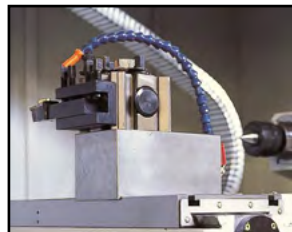

Quick change tool post fitted



Easy retrofit chip conveyor

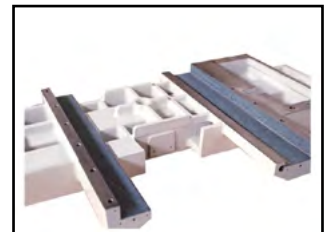

Turcite B with all bearing ways

		BNC-2800A
Swing in gap	mm	970
Swing over bed	mm	710
Swing over cross slide	mm	370
Max. cutting length with turret	mm	1000 / 2000 / 3000 / 4000 / 5000 / 6000
Travel X-axis	mm	425
Travel Z-axis	mm	1200 / 2200 / 3050 / 4050 / 5050 / 6050
Rapid feed X-axis	m/min.	10
Rapid feed Z-axis	m/min.	12
Spindle bore	mm	153
Spindle speed	rpm	125-1480
Spindle motor	kW	15/22 (std.) 22/30 (opt.)
Quill stroke	mm	230
Quill diameter	mm	125
Weight	kg	6000 / 7000 / 8200 / 9400 / 10600 / 11800

# Microcut heavy duty CNC lathe BNC-3000/4000

Best  
Quality



BNC-4000 heavy duty CNC lathe

**MICROCUT's heavy duty CNC lathe BNC-3000/4000 series** is specially designed for heavy duty cutting. With one-piece casting bed made of Meehanite licensed casting (option), the machine is capable of heavy-duty turning. A wide selection of spindle bores including the largest bore of 356 mm for a wide application of various industries is available. The big bore option provides larger bar capacity, especially suitable for the oil & gas industry.

2-step gear box performs high torque spindle power. The smooth and fast speed changing time is to ensure fast working condition.

## Distinctive features:

- High spindle speed & output torque
- NN bearings for 4" & 6" bore spindle support
- Taper roller bearings for 6", 10" & 14" bore spindle support
- Automatic powerful speed changer
- Hydraulic chuck fitting
- Extra wide bed and box way
- Machine offers full Z-cutting capacity
- Long gap bed for disc turning
- Turcite B with all bearing surfaces
- Various selection of turrets
- Heavy loading tailstock
- Lubrication detection monitoring
- Easy retrofit chip conveyor
- Thread repair function

## Standard equipment:

- Fagor 8055i FL CNC control
- Automatic speed changer
- Chuck sliding guard with interlock device
- Gap bed
- Tailstock
- Travelling front single door
- Coolant system
- Lubrication system
- Portable MPG
- Heat exchanger
- CE marking declaration conformity for EU
- Leveling pads
- Tool set & kits

# Microcut heavy duty CNC lathe BNC-3000/4000

Best  
Quality

## Optional equipment:

- Enlarged 153/230/254/355 mm spindle bore
- Turret (hydraulic or electric) & power turret
- Quick change tool post
- Boring/bar base holder
- C-axis
- 5 bar coolant system
- 20 bar coolant through tool
- Rear chuck mounting preparation
- Rear chuck guard
- Manual & hydr. 3-jaw chuck
- Independent manual 4-jaw chuck
- Automatic bar feeder
- Roller steady rest
- Hydraulic steady rest preparation
- Follow rest 20-200 mm
- Hydr. tailstock quill & rotating tailstock quill
- Tailstock end cover with limit switch
- Full enclosure guarding
- Chip conveyor + wash down system
- Oil skimmer
- EMC
- Transformer
- Tool holders
- Available controls:  
Fagor 8055i FL, Fanuc 0iTD with Manual Guide or Siemens 828D basic

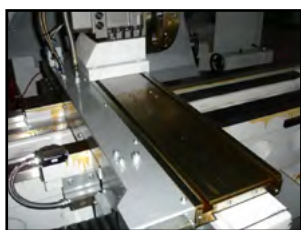

Extra wide cross slide

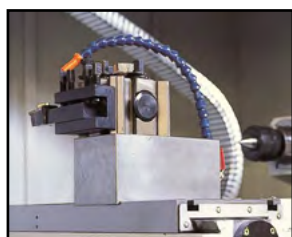

Quick change tool post fitted



Easy retrofit chip conveyor



Turcite B with all bearing ways

		BNC-3000	BNC-4000
Swing in gap	mm	1020	1280
Swing over bed	mm	760	1020
Swing over cross slide	mm	420	680
Max. cutting length with turret	mm	1000 / 2000 / 3000 / 4000 / 5000 / 6000	
Travel X-axis	mm	455	
Travel Z-axis	mm	1150 / 2150 / 3150 / 4150 / 5100 / 6100	1000 / 2000 / 3000 / 4000 / 5000 / 6000
Rapid feed X-axis	m/min.	10	
Rapid feed Z-axis	m/min.	12	
Spindle bore	mm	106 (std.) 153/254/356 (opt.)	91 (106mm bore) 114 (153mm bore) 149 (254mm bore)
Spindle speed	rpm	0-1480 (106/153mm bore) 0-650 (254mm bore) 0-500 (356mm bore)	
Spindle motor	kW	22/33 (std.) 22/26 & 22/30 (opt.)	
Quill stroke	mm	230	
Quill diameter	mm	125	
Weight	kg	9000 - 15000 (depending on model and equipment)	



# Microcut heavy duty CNC lathe BNC-5000

Best  
Quality



**BNC-5000 heavy duty CNC lathe**

**MICROCUT's heavy duty CNC lathe BNC-5000 series** is specially designed with high rigid structure of box way with one-piece bed suitable for heavy duty cutting.

Four guideway bed with high torque output provides the best cutting performance. To offer a one-shot setup and best finishing, C-axis with braking system is available for multiple operations. BNC-5000 can be widely utilised in various fields, such as oil-, construction-, rubber-, iron and steel industries as well as power plants and ship yards.

Built-in 2-step gear box driven by hydraulics for automatic spindle speed change. Gear box is with helical gears ensuring low noise and full power transmission.

## **Distinctive features:**

- High spindle speed & output torque
- Interlocked sliding chuck guard
- Four wide guideways on one-piece bed for heavy loading
- Transmission of feed movement to the longitudinal slide and precision rack with tilted teeth
- Z-axis with linear scale for precision accuracy feedback
- Twin prismatic guideways in inverted "V" for the cross slide
- Motorised movement of tailstock body and quill
- Easy chip removal design
- Various types of turret
- CNC control with "Teach-In" and "thread repair" facility

## **Standard equipment:**

- Fanuc 0iTD control with 10,4" LCD and Manual Guide i
- Helical gear box with automatic speed changer
- Chuck sliding guard with interlock device
- Motorised tailstock
- Travelling front single door interlocked with carriage
- Coolant system
- Lubrication system
- CE marking declaration conformity for EU
- Leveling pads
- Tool set & kits
- Linear scale for Z-axis

# Microcut heavy duty CNC lathe BNC-5000

Best  
Quality

## Optional equipment:

- 4/8 stations automatic turret
- C-axis and live tooling
- Y-axis / B-axis
- Boring bar holder and boring bar
- Tailstock quill axial force measurer
- Chip conveyor
- Grinding head
- Automatic or manual chuck
- Close or open fixed steady rest
- Hydraulic steady rest
- Probe for tools or workpiece measuring
- EMC
- Available controls:  
Fanuc 0iTD, Fagor 8055i Power or Siemens 840D sl control with shop turn



Rigid headstock built-in with gear box

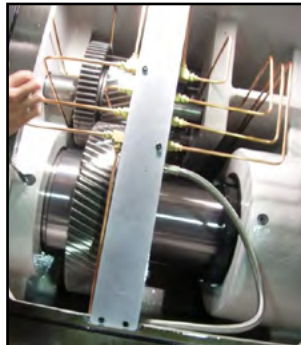

Built-in 2 step gear box with helical gears



Well-protected chuck guard with interlock switch



Twin prismatic guideways in inverted "V" for the cross slide

		BNC-5000
Swing over bed	mm	1300
Swing over cross slide	mm	980
Max. cutting length with turret	mm	3000 / 4000 / 5000 / 6000 / 8000 / 10000 / 12000
Travel X-axis	mm	650
Travel Z-axis	mm	3000 / 4000 / 5000 / 6000 / 8000 / 10000 / 12000
Rapid feed X-axis	m/min.	10
Rapid feed Z-axis	m/min.	10
Spindle bore	mm	Ø153
Spindle speed	rpm	1-800 (Fanuc) 1-1080 (Siemens)
Spindle motor	kW	60/75 (Fanuc) 60/84 (Siemens)
Quill stroke	mm	230
Quill diameter	mm	240
Weight	kg	18 - 45 (depending on model and equipment)

# Microcut CNC flat bed lathe MicroPanther 446

Best  
Quality



**15 m/min.  
rapid feed**

**MICROCUT's CNC flat bed lathe type MicroPanther 446** provides high precision, easy operation, unique features and less maintenance requirement for modern industry, and not least maximum cutting capacity at extremely competitive price.

Easy operation and simulation features, suitable for education or medium production.

MicroPanther 446 offers high spindle speed, high power output and torque and fast rapid feed rate, 15 m/min., which is 2 times faster than the average lathe on the same level. Machining productivity is enhanced with shorter process time.

## Distinctive features:

- Fagor package servo motor and spindle
- A much higher spindle speed & output torque
- Full enclosure with safety control procedure meets CE safety regulation
- Machine is prepared for rear mounted turret
- Single spindle speed transmission
- Hydraulic chuck fitting interface
- E4 or quick change tool post mounted in front or rear side
- User-friendly operation station
- Thread repair, various pitch threading, manual mode, teaching and many other functions

## Standard equipment:

- CNC control Fagor or Siemens
- A2-5 Ø52 mm spindle bore
- Single speed
- Swivel control panel
- Fagor / Siemens package servo motor including spindle and axis servo motors
- Quick change tool post
- Fully enclosed splash guard with interlock safety device
- Automatic lubrication system
- Coolant system
- Tailstock
- Tool set & box, level pads
- Heat exchanger
- CE marking declaration conformity for EU

# Microcut CNC flat bed lathe MicroPanther 446

Best  
Quality

## Optional equipment:

- Manual 3-jaw chuck
- Hydraulic 3-jaw chuck with hard & soft jaw
- 4-jaw independent chuck
- Steady rest
- Follow rest
- Turret (hydr. or electric)
- Joy stick
- Work light
- EMC
- Transformer
- Tool holder package
- Portable MPG
- Tailstock end cover with limit switch
- Available controls:  
Fanuc 0iTF, Fagor 8055i FL or Siemens  
828D basic



X and Z axes featuring box way design assure the best possible machine rigidity and stability



High rigid tailstock provides excellent support when machining. Hydraulic tailstock is available for option.

		MP-446
Swing over bed	mm	446
Swing in gap	mm	546
Swing over cross slide	mm	240
Distance between centers	mm	850
Max. cutting length with turret	mm	650 (QCT) 600 (LS turret)
Travel X-axis	mm	250
Travel Z-axis	mm	760
Rapid feed X-axis	m/min.	15
Rapid feed Z-axis	m/min.	15
Spindle bore	mm	Ø52
Spindle speed	rpm	3000
Spindle motor	kW	5,5 / 7,5
Quill stroke	mm	165
Quill diameter	mm	65
Quill inside taper	MT	4
Weight	kg	2100

# Microcut CNC horisontal boring & milling center HBM Table type Series

Best  
Quality



**MICROCUT's CNC horizontal boring & milling center type HBM** is equipped with a large working table supported with large diameter bearings with high indexing accuracy. The generous dimension of the hydraulic clamping system enables the capability for heavy cutting.

All major structural components are made from Meehanite licensed casting iron. X-, Y- and Z-axes are box way design, perfect for heavy duty, high accuracy machining and high reliability. One-piece bed design ensures high rigidity and vibration resistance.

## Distinctive features:

- Spindle and sleeve are made from chrome alloyed steel
- Spindle and quill are driven by the servo unit and lubricated by sintered bronze to ensure durability and longevity
- Rotary table with large-diameter bearings
- All bearing surfaces are coated with low-friction pad
- Linear scales on three axes ensure exact axial positioning under fluctuation (option)
- C3 class ballscrews with double nuts on X/Y/Z-axes
- All ballscrew nuts are preloaded to ensure less tension deforming, and the ballscrews are with thermal compensation

## Standard equipment:

- Heidenhain, Fanuc or Siemens control with standard software functions
- Auto power off
- Spindle vibration monitoring
- Chip auger for table
- Coolant system
- Hydraulic system
- Auto lubrication system
- Program end and alarm lamp
- Work lamp
- MPG box
- Machining leveling plate
- Oil level detector unit
- Alarm for oil level
- CE marking declaration conformity for EU

# Microcut CNC horisontal boring & milling center HBM Table type Series

Best  
Quality

## Optional equipment:

- Automatic tool changer
- Angular block
- Support stand and rotary arm (HBM-4)
- Safety module
- Air conditioner
- CTS unit
- Oil skimmer
- Power transformer
- Table guard for CTS
- Safety guard for operator
- Tool setting probe
- Work piece probe
- EMC
- Available controls:  
10,4" colour display Fanuc or Siemens, 15" colour display Heidenhain

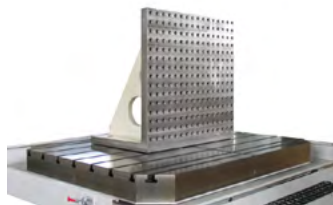

Angular block



Table guard  
with folding  
door



Safety module



CTS unit



Oil skimmer

		HBM-3	HBM-4
Table size	mm	1250 x 1500	1250 x 1500
Table height	mm	1290	1120
Max. table load	kg	5000	5000
Rotary table indexing degree	degr.	1° (std.) / 0,001° (opt.)	1° (std.) / 0,001° (opt.)
X-axis travel	mm	2000	2200
Y-axis travel	mm	1700	1600
Z-axis travel (RAM)	mm	1400	1600
W-axis (quill) travel	mm	550	550
Spindle output	kW	15-18,5	15-18,5
Spindle torque	Nm	740	740
Spindle gear range		2 steps (auto)	2 steps (auto)
Rapid feed X-axis	m/min.	15	12
Rapid feed Y-axis	m/min.	15	12
Rapid feed Z-axis	m/min.	12	12
Rapid feed W-axis	m/min.	6	6
ATC arm type- tools	Nos.	28/40/60	28/40/60
L x W x H	mm	6950 x 4600 x 3900	7750 x 4715 x 3700
Weight	kg	25500	22500

# Microcut CNC horizontal boring & milling center HBM-T type Series

Best  
Quality



**MICROCUT's CNC horizontal boring & milling center type HBM-T** is equipped with a powerful gear box driven spindle, ensuring a high spindle speed, and ISO50 spindle taper. The flexibility of the machine makes it suitable for many different workpieces carrying a weight of up to 10000 kg. The HBM-T can be equipped with numerous technological accessories and various control systems.

Roller type linear guideway takes loads and enables movement in all directions.

## Distinctive features:

- Spindle construction with 2 pcs. NN bearings at the front and rear
- Spindle and quill are driven by the servo unit and lubricated by sintered bronze to ensure durability and longevity
- Rotary table with integrated hydraulic clamping force
- All major structural components are made from Meehanite licensed casting iron
- Linear scales on three axes ensure exact axial positioning under fluctuation
- C3 class ballscrews with double nuts on X/Y/Z/W-axes
- All ballscrew nuts are preloaded to ensure less tension deforming, and the ballscrews are with thermal compensation

## Standard equipment:

- Heidenhain, Fanuc or Siemens control with standard software functions
- Spindle and servo motor package
- Large fully ground work table with 9 T-slots
- Precision ground ball screw
- Heavily ribbed cast iron components
- ISO50 spindle
- Heavy duty radius type metal enclosure with removable slide
- Auto central lubrication
- Coolant system
- Chip drawers
- Telescopic way covers
- 3000 rpm spindle
- Low voltage circuit system
- CE marking declaration conformity for EU

# Microcut CNC horizontal boring & milling center HBM-T type Series

Best  
Quality

## Optional equipment:

- Automatic tool changer
- Angular block
- Safety module
- Air conditioner for electric cabinet
- Oil skimmer
- Table guard for CTS
- Safety guard for operator
- EMC
- Chip conveyor
- Heat exchanger
- Coolant through spindle device
- Spindle extension sleeve
- Right angle milling head
- Universal head
- Facing head
- Lifting device
- Automatic pallet changing system
- Portable MGP
- Available controls:  
10,4" colour display Fanuc or Siemens, 15" colour display Heidenhain



Automatic pallet  
changing system



Heidenhain  
iTNC530 HSCI



Siemens 840D sl



Fanuc 31i/32i

All systems provide full control of 5 axes, especially Heidenhain control comes with spindle rotation function.

		HBM-3T	HBM-4T	HBM-5T	HBM-5TL
Table size	mm	1400 x 1600	1400 x 1600	1800 x 2200	2500 x 2500
Table height	mm	1280	1280	1365	1415
Max. table load	kg	8000	8000 (10000 opt.)	15000 (20000 opt.)	20000
Rotary table indexing	degr.	0,001°	0,001°	0,001°	0,001°
X-axis travel	mm	2000 (3000 opt.)	2000 (3000 opt.)	3500 (4500/5500 opt.)	3500 (4500/5500 opt.)
Y-axis travel	mm	2000	2000	2600 (3200 opt.)	3200 (2600 opt.)
Z-axis travel	mm	1400 (1700 opt.)	1400	1400 (2000 opt.)	2000 (1400 opt.)
W-axis (quill) travel	mm	550	700	700	700
Spindle output	kW	15/18,5	22/30 ; 37/56	37/45 ; 37/56	37/45 ; 37/56
Spindle torque	Nm	740	3002/4093	1942/2362	1942/2362
Spindle gear range		2 steps	2 steps	2 steps	2 steps
Rapid feed X-axis	m/min.	10	10	10	10
Rapid feed Y-axis	m/min.	10	10	10	10
Rapid feed Z-axis	m/min.	10	10	10	10
Rapid feed W-axis	m/min.	6	8	8	8
ATC arm type- tools	Nos.	40T	60T	60T	60T
Weight	kg	43000	40000/42000	49000 - 58000 (depending on X travel)	



# Microcut floor type CNC horizontal boring & milling center HBM-RF type Series

Best  
Quality



**MICROCUT's floor type CNC horizontal boring & milling center type HBM-RF** has high practicality on milling, drilling, boring and threading, suitable for the workpieces with complex shape, e.g. windmill cabinet, parts used in railway industry and components with high-torque performance used in aerospace industry. However, a variety of table combinations are available to meet all industries' demands. A variety of optional milling heads are available for various processes.

A hydraulic compensation mechanism is provided to ensure the linearity of the RAM's spindle and the accuracy of the machine, also called Straightness Compensation Technology "SCT".

## Distinctive features:

- Linear guideway structure RAM
- Extra long travel
- Camlock design for rapid clamping/unclamping of multi-angle head/facing head
- X-axis is rack transmission with roller-type linear guideway to give super stability during heavy loading machining with high speed
- Y-axis guideway is the box way design, integrated with cast iron column, offers strong structure and high rigidity
- V- & Z-axes with roller-type linear guideways provide optimised geometrical accuracy and decrease vibration
- Rotary-type or fixed-type working table selectable for different workpieces
- Interface available for various heads

## Standard equipment:

- Heidenhain iTNC530 HSCI, Fanuc 31iMB or Siemens 840D sl control
- Spindle and servo motor package
- Precision ground ballscrew
- ISO50 spindle
- Coolant system
- Spindle speed 2000~3000rpm
- CE marking declaration conformity for EU
- Heavily ribbed cast iron components
- Automatic central lubrication
- Telescopic covers
- Low voltage circuit system

# Microcut floor type CNC horizontal boring & milling center HBM-RF type Series

Best  
Quality

## Optional equipment:

- Tool setting probe RENISHAW OTS
- Workpiece probe RENISHAW RMP-60
- Tool setting probe BLUM TC-54-20
- Workpiece probe BLUM TC-60
- Angle milling head
- Universal milling head
- NC facing head

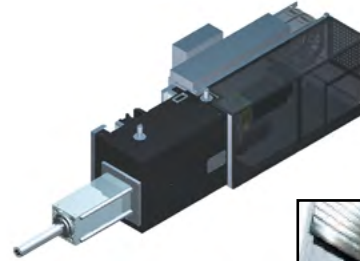

Linear guideway RAM



Universal head



Right angle milling head



Facing head



Facing head



Hydrostatic RAM

		HBM-RF
Table size	mm	2500 x 2500
Table height	mm	1415
Max. table load	T	20 T
X-axis travel	mm	6,000/8,000/10,000/12,000/14,000/16,000
Y-axis travel	mm	3200
Z-axis travel (RAM)	mm	800
W-axis (quill) travel	mm	700
Spindle speed	RPM	2500
Spindle output	kW	Fanuc 37/45
Spindle torque	Nm	2362
Spindle gear range		2 steps (auto)
Quill diameter (W-axis)	mm	Ø140
Rapid feed rate X/Y/V/Z/W-axes	m/min.	10/10/10/10/10
X-axis guideway type		Linear / 65 mm (roller)
Y-axis guideway type		Box way
V-axis guideway type		Linear / 65 mm (roller)
Z-axis guideway type		Linear / 45 mm (roller)
W-axis guideway type		Linear / 25 mm (roller)
ATC arm type- tools	Nos.	60
Weight	kg	43000

# Microcut CNC horizontal boring & milling center HBM RAM type Series

Best  
Quality

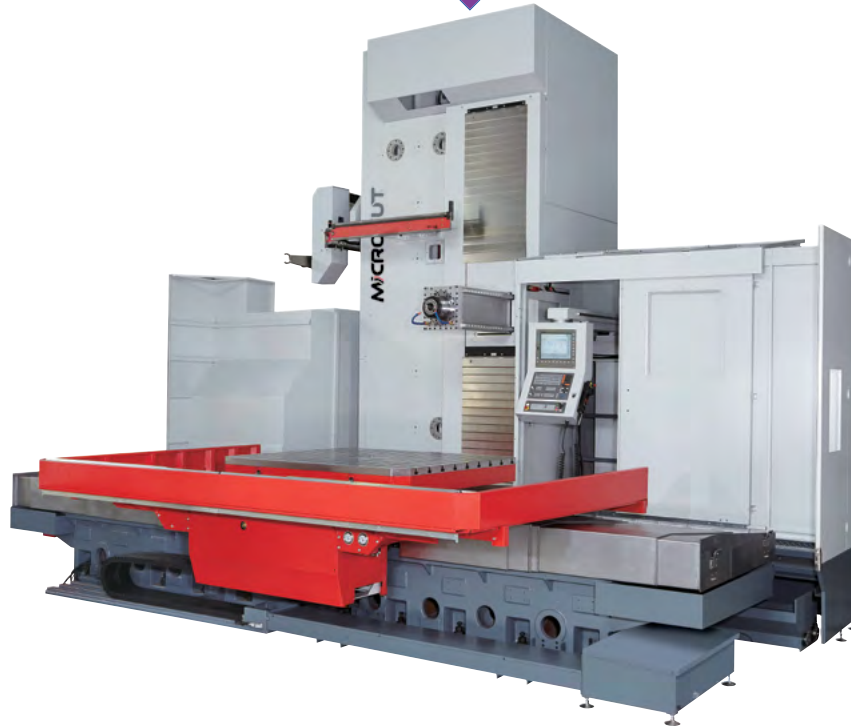

**MICROCUT's CNC horizontal boring & milling center type HBM RAM** is designed with high tensile strength column structure and RAM type spindle with straightness compensation technology "SCT" to ensure rigidity and linearity of RAM when machining. Large operation area with ergonomic control panel provides the comfortable and easy operation.

The main frames are made from high grade Meehanite licensed steel. The rotary table is reinforced with integrated hydraulic clamping force and equipped with four points lock pins to enable heavy loading capacity and large clamping force.

## Distinctive features:

- X/Y-axes provide four-roller type linear guideways with 12 pcs. blocks for X-axis and 16 pcs. blocks for Z-axis for heavy duty loading
- Box way design for Y-axis
- The guideway surface has been processed with induction hardened and ground procedure
- Ø140 mm quill with extendable RAM
- Spindle surface with hardness HRC52-55
- Grade GGG iron casting
- Automatic 2-step speed changer for high torque output
- SCT hydraulic compensation mechanism to ensure linearity of the RAM's spindle and the accuracy of the machine
- C3 class ballscrews with double nuts on X/Y/Z/W axes, which give high axis accuracy and less deforming under axial force

## Standard equipment:

- Heidenhain iTNC530 HSCI, Fanuc 31iMB or Siemens 840D sl control
- CTS preparation
- Spindle oil cooling system
- Chip conveyor incl. water tank and oil skimmer
- Linear scale for three axes
- Heat exchanger
- Measuring system
- Hoist ring set
- Chip auger
- Automatic lubrication system
- CE marking declaration conformity for EU

# Microcut CNC horizontal boring & milling center HBM RAM type Series

Best  
Quality

## Optional equipment:

- Accessory head interface for RAM
  - Angular block
  - Safety module
  - Air conditioner
  - CTS unit
  - Oil skimmer
- Available controls:  
10,4" colour display Fanuc or Siemens, 15" colour display Heidenhain



Angular block



Table guard  
with folding  
door

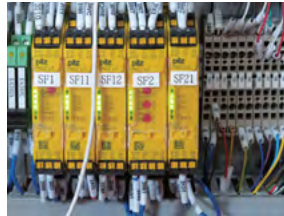

Safety module



CTS unit



Oil skimmer

		HBM RAM
Table size	mm	3200 x 3200 (3500 x 3500 opt.)
Table height	mm	2015
Max. table load	T	20 T (40 T opt.)
X-axis travel	mm	4500 (5500/6500 opt.)
Y-axis travel	mm	3200 (4500 opt.)
Z-axis travel (RAM)	mm	800
V-axis travel (column)	mm	2000
W-axis (quill) travel	mm	700
Spindle speed	RPM	35~3000
Spindle output	kW	37/45
Spindle torque	Nm	1942/2362
Spindle gear range		2 steps
Quill diameter (W-axis)	mm	Ø140
Rapid feed rate X/Y/V-axes	m/min.	10/10/10
X-axis guideway type		Linear / 65 mm (roller)
Y-axis guideway type		Box way
Z-axis guideway type		Linear / 65 mm (roller)
ATC arm type- tools	Nos.	60
Weight	kg	12000

# Universal lathes type EMCOMAT

Best  
Quality



EMCOMAT type 20 D



EMCOMAT type E-300

EMCOMAT are robust, conventional lathes, developed and manufactured in Europe with European components, with great emphasis on environment and costs. User-friendly machines with high flexibility and low maintenance.

## Type D:

- Digital display
- Diagonally ribbed, induction hardened machine bed
- High work speed
- Tailstock can be set off-center

## Type E:

- Large circulating ball screws
- Robust machine bed with strong ribbings
- Hardened guide ways
- Work area protected with sliding doors

EMCOMAT-14 D, 17 D and 20 D are mainly used for high accurate work to be carried out in a small space.

EMCOMAT E-200, E-300, E-360 and E-400 are cycle-controlled lathes for producing simple or complex parts, as one-offs or in small series.

Cycle control type Siemens, Fagor, Heidenhain or Easy Cycle.



Ribbed machine bed



Digital display



Siemens control

## Optional:

- Steady rests (D+E)
- Machine drawer for e.g. tools (D)
- 4-position turret (D)
- Machine lamp (D)
- Additional machine door (D+E)
- Quick-change tool holder (D+E)
- Chip conveyor (E)
- Various clamping devices (E)
- Live center for tailstock (E)

Type		EM-14 D	EM-17 D	EM-20 D	E-200	E-300	E-360/400
Art. no.		18910	18911	18912	18913	18914	18915
Center height	mm	140	170	200	200	275	380 / 430
Distance betw. centers	mm	650	700	1000	1000	1500-3000	2000/4000/6000
Spindle bore	mm	40	50	50	53 / 50	108	153
Chuck Ø	mm	140	200	200	200	315	500
Gear steps		2	4	4	1	1	2
Speed range	RPM	60 - 4000	40 - 3000	40 - 3000	50 - 4000	0 - 2500	0 - 1200
Motor	kW	7,5	5,3	5,3	7,5	25	33
Digital Readout		EMCO	EMCO	EMCO			
Cycle control					Easy Cycle	Siemens 840D sl Fagor 8055i	Siemens 840D sl Fagor 8055i

# Universal lathes type S

Best  
Quality

Made in  
EU  
★ ★ ★



S45



S65

Universal CNC precision lathes for processing bar parts with a diameter of up to 45 and 65 mm and chuck parts of up to 220 and 310 mm using European cutting-edge technology.

## Specifications:

- Designed and produced in Austria
- 2-axis CNC lathes
- C-axis
- Automatic tool turret with driven stations
- Tailstock (option)
- Ideal for bar feeding EMCO SL1200
- Sinumerik 828D or Fanuc 0i control system
- Ideal for series production



Fan wheel,  
brass



Bearing bolt with  
eccentric screw, steel

Type		S45	S65
Bar diameter	mm	45	65
Swing over bed	Ømm	430	540
Swing over cross slide	Ømm	210	360
Max. turning diameter	Ømm	220	310
Max. turning length	mm	510	520
Travel X-axis	mm	160	210
Travel Z-axis	mm	310	610
Speed range		0-6300	0-4200
Motor	kW	11	18
C-axis rapid speed	RPM	1000	1000
C-axis spindle indexing		0,01"	0,01"
Aut. tailstock (option) travel	mm	460	500
Tools / driven		12 / 6	12 / 12
Control system		Siemens / Fanuc	

# CNC lathes type CONCEPT TURN

Best  
Quality

Made in  
EU



CONCEPT TURN 105



CONCEPT TURN 460

CONCEPT TURN are robust CNC-controlled lathes, developed and manufactured in Europe with European components, with great emphasis on environment and costs. User-friendly machines with high flexibility and low maintenance.

CONCEPT TURN are mainly used for small businesses or CNC training. They are very flexible, and thanks to its modular design it can be connected to a CIM network and equipped with training software.

## Standard:

- CW/CCW spindle rotation
- Linear guides
- Constant cutting speed
- Infinitely adjustable main drive
- Automatic 8/12-position tool turret
- Optimum guide ratio for the slides for max. stability and precision

## Optional:

- Interchangeable control - EMCO WINNC
- Electronic hand wheel
- Multimedia training material
- USB keyboard with TFT display
- Portable machine operating panel
- Manual tailstock to support long workpieces
- Hydraulic tailstock
- Machine base with swivel table
- Tools & holders
- Chip conveyor

Type		CT 60	CT 105	CT 260	CT 460
Art. no.		18920	18921	18922	18923
Swing Ø over bed	mm	130	180	250	430
Max. turning diameter	mm	60	75	85	220
Distance betw. centers	mm	335	236	405	670
Travel X/Z or Z/Y/X	mm	60 / 280	55 / 172	100 / 300	160 / 510
Rapid speed X/Z	m/min.	3	5	15 / 24	24 / 30
Motor	kW	1,1	1,9	5,5	13
Speed range	RPM	300 - 4200	150 - 4000	60 - 6300	0 - 6300
Tools / driven		8 / 0	8 / 0	12 / 6	12 / 6

# CNC lathes type EMCOTURN

Best  
Quality

Made in  
EU  
★ ★ ★



EMCOTURN 25



EMCOTURN 65 with Compact Load

EMCOTURN type E are robust industrial CNC-controlled lathes, developed and manufactured in Europe with European components, with great emphasis on environment and costs. User-friendly machines with high flexibility and low maintenance.

## Standard:

- Powerful main spindle
- 12-station tool turret
- VDI rapid change system
- Driven tools
- Tailstock
- Linear guides in all axes
- EMCO Automation
- Compact Load Package E65

## Work pieces:



Bar stock diameter E25

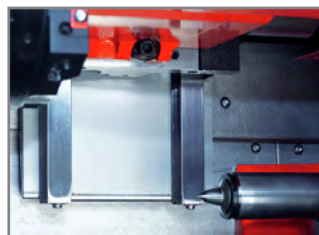

Roller guides E25

## Optional:

- Part catcher
- Automatic door system
- Chip conveyor
- Tool holder packages
- Tool measurement sensor
- High-pressure coolant system

Type		E25	E45	E65
Art. no.		18925	18926	18927
Bar capacity	mm	25,5	45	65
Swing Ø over bed	mm	250	430	540
Chuck	mm	95	160 / 200	200 / 250
Travel X / Y / Z	mm	100 / 300	160 / 70 / 510	210 / - / 610
Rapid motion speed X / Y / Z	m/min.	15 / 24	24 / 10 / 30	24 / - / 24
Speed range	RPM	60 - 6300	0 - 6300 (5000)	60 - 4200
Motor	kW	5,5	13	18
Tools / driven		12 / 6	12 / 6	12 / 12



# CNC lathes type MAXXTURN

Best  
Quality

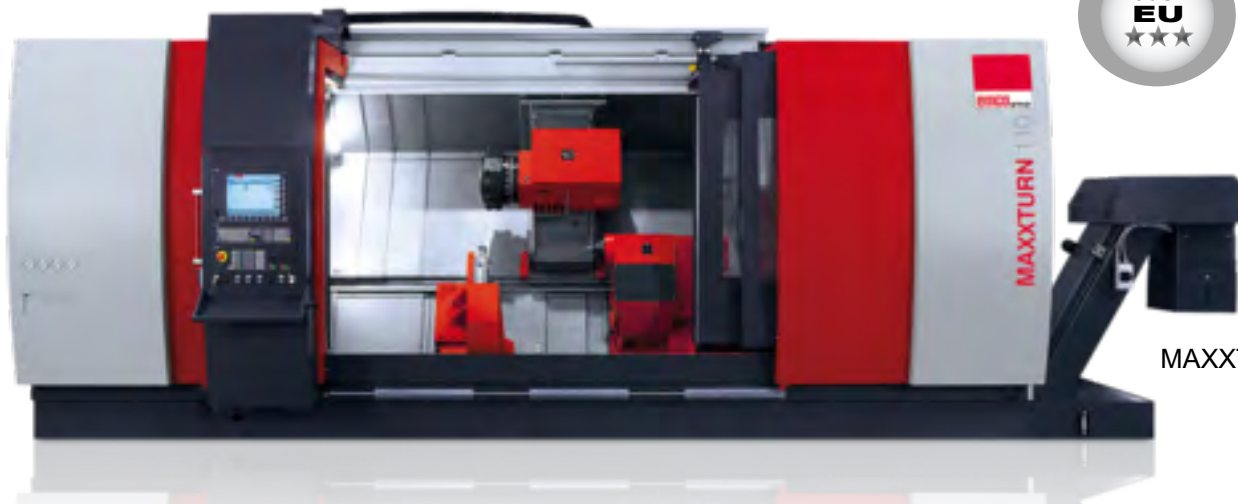

MAXXTURN 110

MAXXTURN type MT are robust industrial CNC-controlled lathes, developed and manufactured in Europe with European components, with great emphasis on environment and costs. User-friendly machines with high flexibility and low maintenance.

MAXXTURN are complete machines for complex turned and milled parts. The high-light is the very stiff Y-axis with large travel, for almost unlimited machining capabilities with maximum precision.

## Standard:

- Powerful main spindle
- Fully functional sub-spindle
- Automatic tailstock
- 12-station tool turret
- VDI rapid-change system
- Driven tools for milling and boring
- Y-axis directly implemented in the machine construction
- NC-controlled steady rest
- Linear guides in all axes
- EMCO Automation

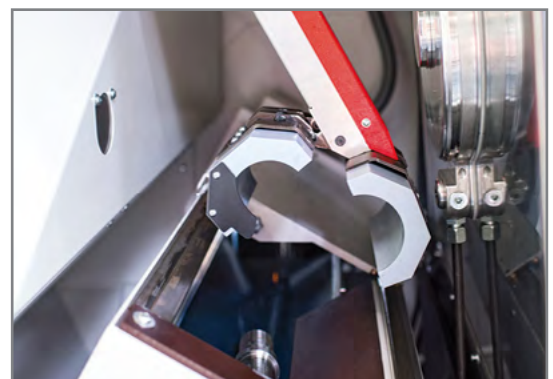

Parts pick-up device

Type		MT25	MT65	MT95	MT110
Art. no.		18930	18931	18932	18933
Bar capacity	mm	25,4	65 / 76 / 95	95	95 / 110
Swing Ø over bed	mm	325	660	700	820
Chuck Ø	mm	95	200 (250)	315 / 400	315 / 630
Travel X / Y / Z	mm	100 / 35 / 320	260 / 100 / 800	303 / 140 / 1160	420 / 180 / 1560-3560
Rapid speed X / Y / Z	m/min.	20 / 10 / 30	30 / 12 / 30	24 / 12 / 30	24 / 12 / 30
Speed range	RPM	0 - 8000	0 - 5000	0 - 3500	0 - 3500 / 2500
Motor	kW	6,5	29	33	33 / 52
Tools / driven		6	12	12	12

# CNC lathes type MAXXTURN

Best  
Quality

## MAXXTURN accessories:

MAXXTURN type MT is available with various optional equipment depending on the size of the lathe and the work process.

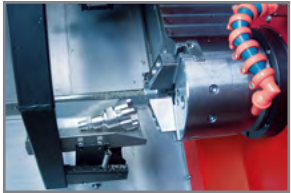

Part catcher



Part catcher conveyor



Bull's eye

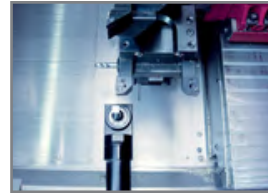

Tool measurement



Band filter with high pressure coolant pumps



Emco tool break monitoring



Steady rest



Chip conveyor



Automatic door system



Electrical hand wheel 840D SL

## MAXXTURN work pieces:

A selection of various workpieces produced on a MAXXTURN type MT lathe.



Tool turret disc, steel



Wheel rim, alu



Drive shaft, steel



Adjustor sleeve, stainless st.

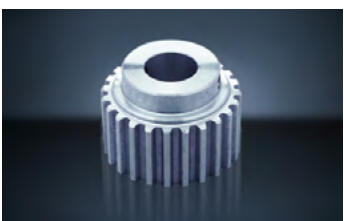

Drive pulley, alu



Winch, brass



Distributor, brass



Spirit level

# CNC lathes type HYPERTURN

Best  
Quality

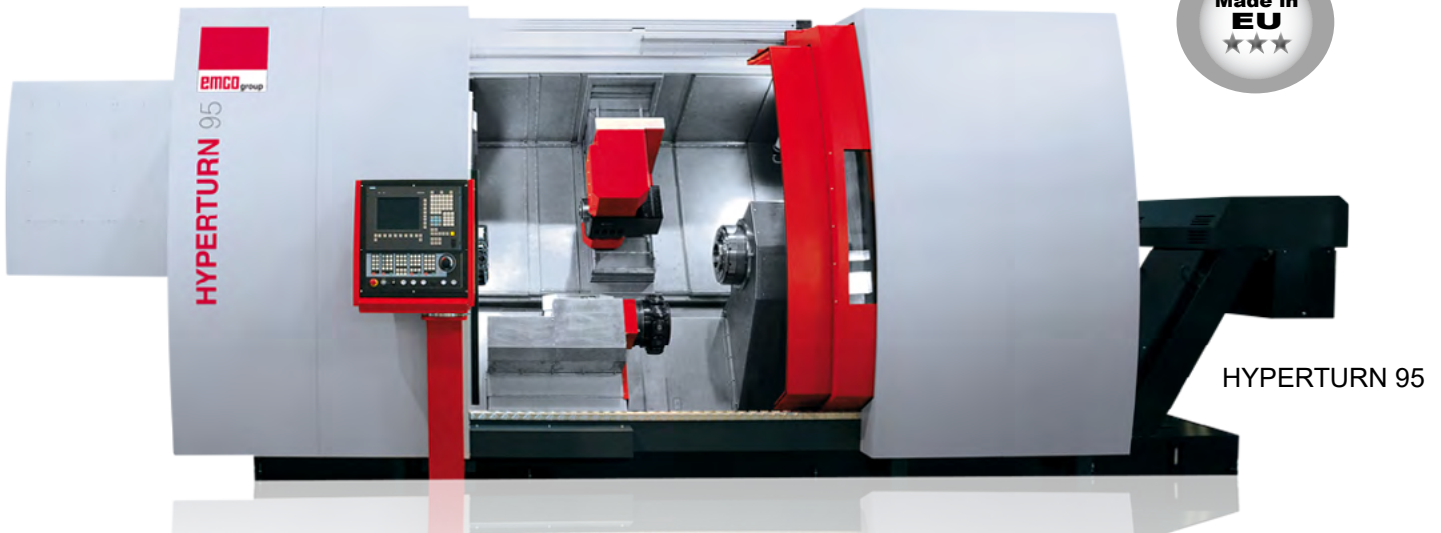

HYPERTURN 95

HYPERTURN type HT is a brilliant fusion of state-of-the-art turning and milling technology. The machines are developed and manufactured in Europe with European components, with great emphasis on environment and costs. User-friendly machines with high flexibility and low maintenance.

The aim: to increase productivity when processing complex workpieces. HT is equipped with Y axis, B axis and the latest control and drive technology. Combined with innovative turnkey solutions it is an allround machine for the machine tool industry.

## Standard:

- Powerful main and sub-spindles
- 2 x 12-station tool turrets
- 2 x 12 drive tool positions
- Milling spindle with direct drive
- Driven tools for milling and boring
- 40/80 or 50/100/200 station tool magazine depending on the machine model
- Y-axis with large travel
- Linear guides in all axes
- EMCO Automation



HYPERTURN 65

Type		HT45	HT65	HT95	HT110
Art. no.		18935	18936	18937	18938
Bar capacity	mm	45 (A2-5)	65 (A2-6,-8)	95 / A2-8	110 / A2-11
Swing Ø over bed	mm	430	660	720	720
Chuck size	mm	160	200 (250)	315 (400)	400 (630)
Travel X / Y / Z	mm	160 / 70 / 510	260 / 100 / 800-1050	540 / 240 / 1300-1900	540 / 240 / 1300-1900
Rapid speed X / Y / Z	m/min.	30 / 15 / 45	30 / 12 / 30	30 / 30 / 30	30 / 30 / 30
Speed range	RPM	0 - 7000	0 - 5000	0 - 3500	0 - 2500
Motor / torque	kW / Nm	15 / 100 Nm	29 / 37 / 250	33 / 800	52 / 2400
Driven tools		2 x 12	1, 2, 3 x 12	2 x 12	2 x 12

# CNC lathes type HYPERTURN

Best  
Quality

## HYPERTURN accessories:

HYPERTURN type HT is available with various optional equipment depending on the size of the lathe and the work process.



Removal of workpieces up to 45 mm via counter spindle

### Optional:

- Band filter system w. high-pressure coolant pumps
- Finished part conveyor belt
- Emco tool breakage monitoring system - the tool status is monitored by evaluating the load on the various axis drive motors.
- Manual tool gauge, quick and accurate measure on both turrets in the work area.
- Unloading through the sub-spindle
- Spin-Window
- Turret-steady-rest / Live center
- BMT-Turret w. water cooled direct drive
- Tailstock



The optional spin-window enables optimal insight in the working area, also during machining with coolant. Due to its very fast rotating glass plate, the coolant is slung away immediately after impact and the window stays clear.

## HYPERTURN work pieces:

A selection of various workpieces produced on a HYPERTURN type HT lathe.



Hip-joint disc, titanium alloy



Tappet, steel



Dental tool angle piece, brass



Eccentric flange, steel



Adapter, steel



Starter pinion, 42 Cr Mo 4

# Vertical lathes type VT

Best  
Quality



EMCO Vertical VT 400



VT Vertical lathe has various automation options

Vertical lathes type VT are designed for heavy-duty machining. The lathes are developed and manufactured in Europe with European components, with great emphasis on environment and costs. User-friendly machines with high flexibility and low maintenance.

The VT series is equipped with an integrated self-loading system and even though, it gets along with a small foot print. High productivity, high repeat accuracy and good operability are the convincing product features.

## Standard:

- Ready for heavy machining
- Small footprint
- Self-loading automation included
- New Siemens control
- Free chip fall

## Optional:

- High-pressure coolant pump
- Electronic hand wheel - CNC
- Milling tools and Y-axis
- Automatic work piece measuring
- Multifunctional plate
- Multiple automation options

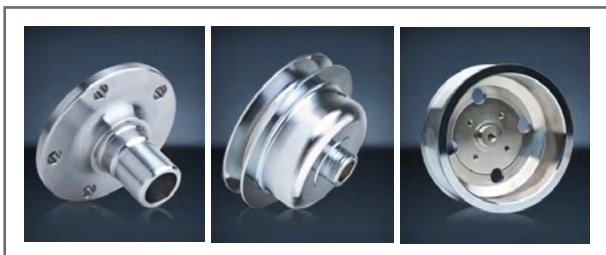

Automatic work piece measuring



Multi-functional plate, supports long drilling tools

Type		VT160	VT260	VT400
Art. no.		18940	18941	18942
Max. work piece length	mm	150	180	200
Max. work place diameter	mm	160	260	400
Chuck	mm	160	260	400
Travel X / Y / Z	mm	620 / + - 65 / 310	660 / + 70 - 90 / 310	960 / + - 90 / 400
Rapid motion speed X / Y / Z	m/min.	60 / 15 / 30	60 / 15 / 30	45 / 15 / 30
Speed range	RPM	0 - 7000	0 - 5000	0 - 4000
Motor	kW	21	29	36
Driven tools		12	12	12

# Milling machines type EMCOMAT

Best  
Quality



EMCOMAT type FB-3



Vertical milling head



EMCOMAT type FB-600 MC

EMCOMAT type FB are conventional universal milling machines mainly used where highly precise work needs to be carried out in a small space. The machines are developed and manufactured in Europe with European components, with great emphasis on environment and costs. User-friendly machines with high flexibility and low maintenance.

For the production of small series or larger work pieces the cycle-controlled milling machines represent an efficient alternative.

## Standard:

- Vertical milling head with swiveling unit
- Safety hand wheels in X and Y axis
- Covered spindle and carriage clamping
- Machine base
- Swivel digital display

## MC-Version:

- Reversible main spindle
- Shafts and gears hardened and ground
- Linear guides
- Main motor with spindle brake
- Milling spindle supported radially and axially in four bearings
- Sinumerik or Heidenhain control

## Optional:

- Various clamping devices
- Overarm for horizontal milling
- Machine lamp
- Measuring tools & Various measuring devices
- Swivel-mounted dividing head
- Safety cover
- SK40 tool storage system



Type		FB-3	FB-450 MC	FB-600 MC
Art. no.		18950	18951	18952
Travel X / Y / Z	mm	300 / 200 / 350	450 / 350 / 400	600 / 400 / 400
Clamping area	mm	600 x 200	800 x 400	800 x 400
Gear steps/control		8 / mechanical	1	1
Speed range	RPM	80 - 2200	10 - 5000	10 - 5000
Motor	kW	1,4	10	13
Position display		Heidenhain	EMCO	EMCO
Control			Heidenhain, Easy Cycle	Heidenhain, Easy Cycle

# Milling machines type CONCEPT MILL

Best  
Quality



CONCEPT MILL 55



CONCEPT MILL 260

CONCEPT MILL CNC milling machines are flexible machines ideal for small businesses or CNC training. Thanks to its modular design it can be connected to a CIM network and equipped with training software and courseware. The milling machines has a wide range of automation options.

The machines are developed and manufactured in Europe with European components, with great emphasis on environment and costs. User-friendly machines with high flexibility and low maintenance.

## Standard:

- Compact CNC machine
- 8-, 10- and 20 station tool changing system
- Dividing attachment as 4th axis (55/105)
- Interchangeable WinNC control (260)
- Optimal view despite fully enclosed work area
- Profile rail guides (260)
- Digital drive technology (260)



## Optional:

- Interchangeable control - EMCO WINNC
- Electronic hand wheel
- USB keyboard with TFT display
- Portable machine operating panel
- NC tilting rotary table as fourth axis (260)
- Engraving spindle attachment (55/105)
- Tools and holders
- Rotating and swivelling unit DSE200 (260)
- Chip conveyor (260)

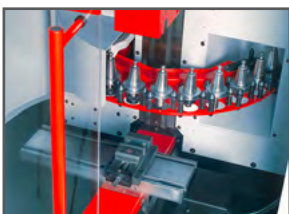

8-station CM 55



20-station CM 260

Type		CM 55	CM 105	CM 260
Art. no.		18955	18956	18957
Travel X / Y / Z	mm	190 / 140 / 260	200 / 150 / 250	350 / 250 / 300
Rapid motion speed X / Y / Z	m/min.	2	5	24
Motor	kW	0,75	1,1	6,8
Speed range (option*)	RPM	150 - 3500 (14000*)	150 - 5000 (20000*)	150 - 10000
No. of tools		8	10	20

# Milling machines type EMCOMILL

Best  
Quality



EMCOMILL E350



EMCOMILL 1200

EMCOMILL CNC are flexible, economical milling machines. The machine generation for the standard 3-axes milled part production is the answer to challenging CNC milling for small to medium lot sizes at an unbeatable value for money.

The machines are developed and manufactured in Europe with European components, with great emphasis on environment and costs. User-friendly machines with high flexibility and low maintenance.

## Standard:

- High-performance milling spindles
- Flexible tool system
- Solid work table
- State-of-the-art control technology from Siemens and Fanuc
- Large number of options
- Best price-performance ratio
- Mechanical spindle (E350)
- JobShop programming software (E350)

## Optional:

- EMCO tool breakage monitoring system
- Dividing unit
- Electronic hand wheel
- Automatic workpiece measuring
- Tool station with 40 tool stations
- High-pressure coolant pump
- Rotary table as 4th axis



Rotary table



Machine base made from vibration damping polymer concrete

Type		E 350	EM 750	EM 1200
Art. no.		18960	18961	18962
Travel X / Y / Z	mm	350 / 250 / 300	750 / 550 / 500	1200 / 600 / 500
Rapid motion speed X / Y / Z	m/min.	24 / 24 / 24	30 / 30 / 30	30 / 30 / 30
Clamping area	mm	500 x 30	900 x 630	1300 x 630
Table load	kg	100	800	1500
Speed range	RPM	50 - 10000	50 - 10000 / 15000	50 - 10000 / 15000
Motor	kW	7	15 / 20	15 / 20
Tool magazine	spaces	20	30 (40)	30 (40)
Tool holders		SK30 DIN 69871	ISO40 (BT40, HSK-A63)	ISO40 (BT40, HSK-A63)



# Milling machines type MAXXMILL

Best  
Quality

Made in  
EU

★ ★ ★



MAXXMILL 500



MAXXMILL 400

Maxxmill is the ideal vertical milling center for the 5-sided machining of parts in low or medium quantities. It is the perfect machine for jobshops, industrial businesses (e.g. automobile vendors), general mechanical engineering companies and further education facilities.

The machines are developed and manufactured in Europe with European components, with great emphasis on environment and costs. User-friendly machines with high flexibility and low maintenance.

## Standard:

- 5-axis machining in one operation
- Top thermostability
- Top cutting precision
- Mechanical or motor spindle
- Cutting-edge control technology from Siemens and Heidenhain
- Modern moving column concept
- Compact machine design
- Machine swivel-rotary table
- Optimal chip removal
- Attractive price-performance ratio

## Optional:

- Automatic workpiece measuring
- Laser device for presetting breakage check and profile measuring tools
- High-pressure coolant pump
- Rotary coupling through tilting table

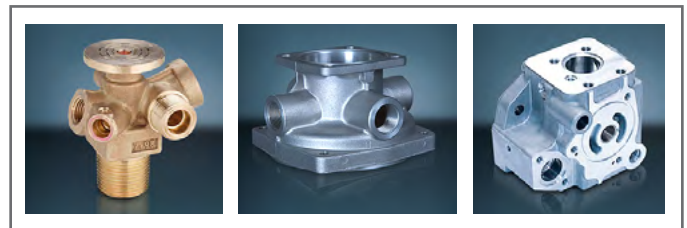

Type		MM 400	MM 500
Art. no.		18965	18966
Travel X / Y / Z	mm	350 / 250 / 300	650 / 550 / 500
Rapid motion speed X / Y / Z	m/min.	30 / 30 / 30	30 / 30 / 30
Table diameter / Clamping area	mm	Ø400 mm	600 x 600
Table load	kg	50	250
Speed range	RPM	50 - 12000 / 24000	50 - 10000 / 15000
Motor	kW	7	15 / 20
Tool magazine	spaces	20 (30, 50)	30 (40)
Tool holders		20 (30, 50) ISO30, 30 (50) HSK-A40	ISO40 (BT40, HSK-A63)

# Milling machines type MMV

Best  
Quality



MMV 2000

Emco milling machines type MMV are developed and manufactured in Europe with European components, with great emphasis on environment and costs. User-friendly machines with high flexibility and low maintenance.

The MMV is the perfect machine for 3- to 5-axis machining of small and medium batch sizes for use in general mechanical engineering. Extremely solid machine for machining large and heavy work pieces. The machine provides maximum precision and highest surface qualities even with high machining power.

## Standard:

- Roller guide ways
- Direct driven ball screws with rapid feed up to 50 m/min.
- Moving column machining center with B-axis and rotary table
- Tool magazine with 30-120 tool stations
- High cutting power
- Pendulum operation possible



Control unit

## Optional:

- Automatic workpiece measuring
- Laser device for presetting breakage check and profile measuring tools
- High-pressure coolant pump
- Rotary coupling through tilting table
- Linear scales

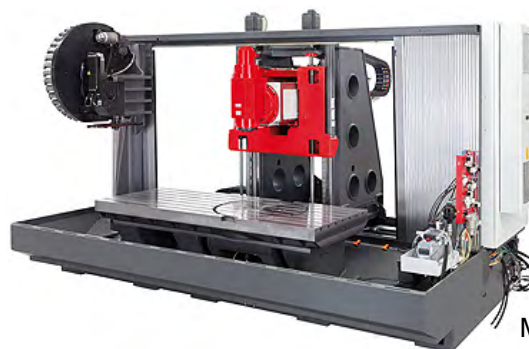

Machine construction

Type		MMV 2000	MMV 3200
Art. no.		18968	18969
Travel X / Y / Z	mm	2000 / 800 / 750	3200 / 1000 / 950
Rapid motion speed X / Y / Z	m/min.	50 / 50 / 50	50 / 50 / 50
Clamping area	mm	2400 x 950 mm	3500 x 1050
Table load	kg	2200	5000
Speed range	RPM	50 - 12000	50 - 15000
Motor	kW	46	46
Tool magazine	spaces	30 (40 or 60)	40 / 60-120
Tool holders		ISO40 (BT40)	ISO40 (BT40)

# First milling machines type LC1-1/2 VS

Best  
Quality



## The machine is delivered with:

- Motorised feed on X,Y and Z-axis
- 3-axis digital read out
- Pneumatic clamping
- Head swivel + / - 90°
- Automatic lubrication
- Coolant system
- Dynamically balanced
- Halogen work light
- Tools
- Hardened and ground guideways

**Swivel milling head**  
+ / - 90°

**3-axis digital read out**

**Motorised X, Y and Z-axis**

**Variable spindle speed 50-3750 RPM**

Technical data		LC1-1/2
Art. no.		17650
Table dimension	mm	1067x230
Table travel X-axis	mm	762
Table travel Y-axis	mm	305
Table travel Z -axis	mm	406
Quill travel	mm	127
Vertical feed	mm/r	0,04 ; 0,08 ; 0,16
Variable spindle speed	RPM	50 - 3750
T-slots		3 pcs / 16 x 30mm
Spindle taper		ISO 30 (Opt. ISO 40)
Milling head		90° swivel right/left 45° tiltable forwards/backwards
Spindle to table	mm	0 – 469
Table load	kg	200
L x B x H	mm	1600 x 1467 x 2100
Motor	kW	1,5
Weight	kg	1010

# First milling machines type LC-20

Best  
Quality

## Standard equipment for LC-20:

- Type LC-20 VHS with horizontal spindle
- Motorised feed on X,Y and Z-axis
- 3-axis digital read out
- Pneumatic clamping
- Head swivel
- Automatic lubrication
- Coolant system
- Dynamically balanced
- Halogen work light
- Tools
- Hardened and ground guideways



Technical data		LC-20 VSG	LC-20 VHS
Art. no.		17655	17660
Table dimension	mm	1300x260	1300x260
Table travel X-axis	mm	800	800
Table travel Y-axis	mm	415	415
Table travel Z -axis	mm	460	435
Quill travel	mm	127	127
Speed X-axis	mm/min	22-690	22-690
Rapid feed X-axis	mm/min	2100	2100
Speed Z-axis	mm/min	800	800
Spindle speed	RPM	Vertical: 50 - 3750 Variable	Vertical: 16 / 60 - 3000 Horizontal : 6 / 45 - 980
Feed	mm/r	0,04 ; 0,08 ; 0,16	0,04 ; 0,08 ; 0,16
T-slots		3 pcs / 15,875 x 63,5mm	3 pcs / 15,875 x 63,5mm
Spindelkonus		ISO 40	ISO 40
Milling head		90° swivel right/left 45° tiltable forwards/backwards	90° swivel right/left 45° tiltable forwards/backwards
Spindle to table	mm	80-540	115 - 550
Table load	kg	200	200
L x B x H	mm	2110 x 1900 x 2270	2110 x 1900 x 2270
Motor	kW	3,3	3,3
Motor Z-axis	kW	1,15	1,15
Weight	kg	1800	2010

# Style CNC lathe

Best  
Quality

Made in  
EU  
★★★

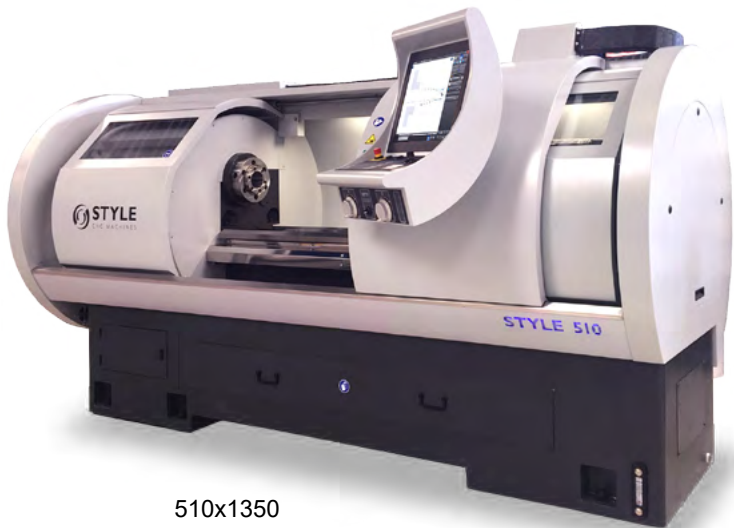

510x1350



320x500

Style is among the leading companies in production of lathes and milling machines of superior quality. The philosophy of Style is to bring programming times, and thereby changing times of changeovers on small series to an absolute minimum. Single series and flexibility are the key words. All Style machines are equipped with the latest Style 4 controller, which is the fastest, most powerful and intuitive software for lathes and milling machines.

Style 4 controller is the result of many years of experience from programmers and customers. The advantages and simplicity of previous versions, but now with the latest applications in intuitive programming. The speed and ease of use of this control is not comparable. Each operation is done with a few clicks, a minimum of required values displayed directly on a 19" touch screen. Simplicity combined with options from CNC.

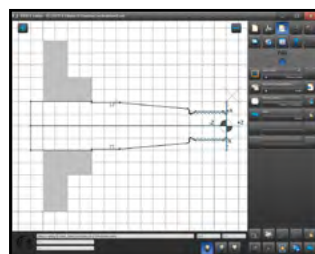

*Style-control makes it easy for you. Operators who are used to traditional machines can work directly with Style Teach-in machines. The software is written in Danish. The machines can be supplied with an optional software package, making it possible to develop programs and work on a remote PC.*

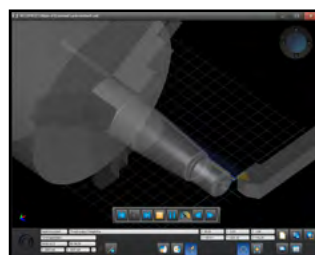

*The graphic dialogue program enables you to program / design a product quickly and easily get it done on the machine. You can also import a DXF file.*

*You can simulate all stages of the production process on the screen in 3D in order to verify the application you have made.*

# Style CNC lathe

Best  
Quality



## Graphic full touch

Graphic full touch 19" screen combined with smart menus are not only fast, but retains a constant overview of the process. No unnecessary dialogs or input fields.

## Smart menus

Smart Menu understand what your next step will be during programming. This means fewer actions, so you can work smarter and faster.

The menus are arranged such that only the available logical programming options are visible. In this way, the menu is always clear and concise and you work faster every day.

## Simulation

With the simple and lightning-fast 3D simulation functionality on a STYLE 4 Controller, it is possible to pre-test and optimize every single subject. Furthermore the production time and the tools necessary for processing is calculated directly in the simulation.

## G-Code

With the special style CNC editor it is possible to make ISO programming, and thereby produce very complex pieces in a very simple way. This enhances the operator's flexibility considerably. G-Code functionality allows you to program different complex forms and operations within the intuitive environment STYLE 4 controller provides its users!

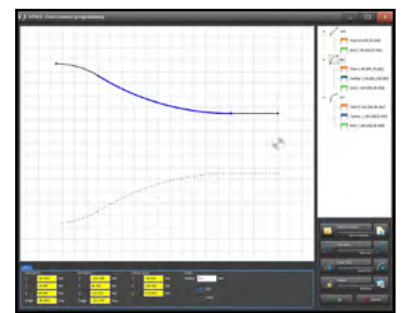
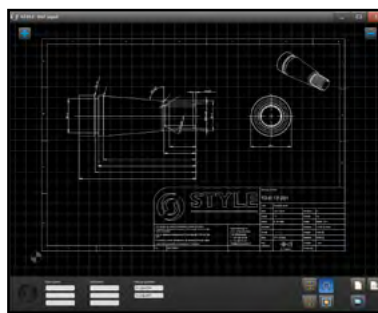
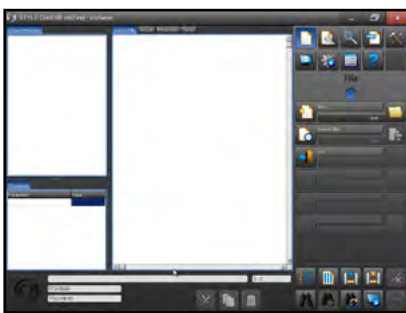

## Standard equipment:

- Pentium 4 3.0Ghz PC
- Style control m. Style 4 software
- 512Mb RAM
- 19" LCD" Touch "color display
- USB connection
- Network Connectivity
- Digital positioning if manual mode is selected
- Hardened and ground beams
- A. C. spindle motor with electro-magnetic brake
- D.C. motors for the X and Z movement
- Precision ground ball screws
- Electronic handwheel for X and Z movement
- Aut. Central lubrication systems
- Coolant
- Conversion Program
- DXF files
- Full guard protection
- Work light
- Constant cutting speed
- Various safety devices properly. CE directive.
- The machines are supplied without centering device and without tool system
- Chip conveyor (only on 650/750 models)
- CE approved

# Style CNC lathe

Best  
Quality



## Optional:



350

- Centering chuck manual
- Multifix quick change system
- Automatic tool changer
- VDI30 8-pos.
- 7,5kw engine
- Chip conveyor
- Follow rest Ø10-75mm
- Steady rest Ø10-150mm
- High-pressure cooling
- 1 year extra warranty
- Additional software



510

- Centering chuck manual
- Multifix quick change system
- Automatic tool changer VDI30 / VDI40 8-pos.
- 11kw motor
- Chip conveyor
- Follow rest Ø10-75mm
- Steady rest Ø20-150mm / Ø100-300mm
- Spindle bore Ø103mm
- High-pressure cooling
- 1 year extra warranty
- Additional software

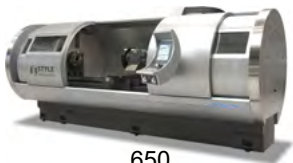

650

- Centering chuck manual
- Multifix quick change system
- Automatic tool changer VDI40 / VDI 50 8-pos.
- 22kW motor
- Chip conveyor
- Follow rest Ø20-160mm
- Steady rest Ø50-300mm / Ø60-400
- C-axis w.rotating tools
- High-pressure cooling
- 1 year extra warranty
- Additional software



750

- Centering chuck manual
- Multifix quick change system
- Automatic tool changer VDI40 / VDI 50 8-pos.
- 22kW motor
- Chip conveyor
- Follow rest Ø20-160mm
- Steady rest Ø50-300mm / Ø60-400
- C-axis w.rotating tools
- Spindle Ø155mm
- High-pressure cooling
- 1 year extra warranty
- Additional software

Technical data		Style 300	Style 350	Style 510	Style 650	Style 750
Distane btw. centers	mm	500	850	1350 / 1850	1900 / 2900 / 3900	
Width of bed	mm	190	305	330	450	450
Swing over bed	mm	320	380	510	650	750
Swing over cross slide	mm	180	190	300	430	530
Spindle bore	mm	40	42 / 52	80	105	105
Speed range	RPM	4000	3000	2500 / 1800	2000	2000 / 1000
Camlock		D1-4	D1-6 / D1-5	D1-8	D1-11	D1-11 / A2-11
Motor	kW	3,7	5,5	7,5	18,5	18,5
Weight	kg	800	2000	2700 / 3200	5500 / 6600 / 7700	5700 / 6800 / 7900
Dimensions	mm	1800x1000x1200	2500x1800x1800	3200x1800x1800 3700x1800x1800	4100x2300x2200 5100x2300x2200 6100x2300x2200	4100x2300x2200 5100x2300x2200 6100x2300x2200

Style lathes are available up to size 1200 - ask for specifications

# Style CNC milling machine - Teach In

Best  
Quality

Made in  
EU  
★★★



BT2000

Style CNC milling machine offers faster programming times and faster switching times between series - these machines are simply unmatched in its class and provides optimum flexibility to handle a wide range of products.

The frame consists of heavy cast iron. The X-axis is supported with guides. Y and Z axes are reinforced with strong box beams. Guides are induction hardened and grounded. Beams are coated with Turcite-B. The main spindle is provided with FAG high precision bearings and are standard suitable to run 8,000 rev. / Min. without the use of cooling. X, Y and Z axes is provided with NSK ball screws which ensure the highest possible accuracy.

The machine is equipped with an automatic central lubrication system. Servo motors, frequency converters, controls and all electrical components are installed in the Netherlands at STYLE High Tech. Here, all components will be checked by an extremely comprehensive quality check. Style service ensures proper and professional delivery. There are also telephone helpdesk, where it is possible to be advised about the software. The machine is suitable for single pieces and small series. Programming skills are not needed because of the very user-friendly software. It is possible to learn to work with the machine in just 1-2 days.

The machine complies with CE standards and will be delivered with manual in the rightful language.





# Style CNC milling machine - Teach In

Best  
Quality



## Optional:



BT600

- Vertical tool changer 16/24-pos.
- Closed machine frame incl. chip conveyor
- 8000 rev. / min

- 7.5 kW motor
- Internal cooling
- External high-pressure pump
- Amp. meter

- RPM potentiometer
- 1 year extra warranty
- Additional software



BT1000

- Vertical tool changer 20/24-pos.
- Closed machine frame incl. chip conveyor
- 8000 rev. / min

- 11 kW motor
- Internal cooling
- External high-pressure pump
- Amp. meter

- RPM potentiometer
- 1 year extra warranty
- Additional software



BT1500 / BT1500E

- Vertical tool changer 24-pos.
- Closed machine frame incl. chip conveyor

- 8000/10000/12000 rev. / min
- 11/15 kW motor
- Internal cooling
- External high-pressure pump

- pump
- Amp. meter
- RPM potentiometer
- 1 year extra warranty
- Additional software



BT2000 / BT3000

- Vertical tool changer 24-pos. BT40/BT50
- Closed machine frame incl. chip conveyor
- 8000/10000/12000 rev. / min

- 15/18/22/37 kW motor
- Internal cooling
- External high-pressure pump
- Amp. meter
- RPM potentiometer

- 1 year extra warranty
- Additional software
- BT50 spindle
- ZF gearbox

Technical data		Style BT600	Style BT1000	Style BT1500/1500E	Style BT2000 / 3000
Art. No.		18870	18872	18874 / 18876	18878 / 18880
X axis	mm	660	1060	1500	2000 / 3000
Y axis	mm	410	560	650	800
Z axis	mm	500	600	600	700
Spindle to table	mm	125-735	110 - 710	150-850	150-850
Table size	mm	360x880	465x1240	500x1810 / 610x1810	600x2150 / 800x3200
T-slots	mm	3x18	4x18	5x18	5x18 / 5x22
Table capacity	kg	400	1000	1300 / 800	2000 / 2500
Spindle taper		BT40	BT40	BT40	BT40 / BT50
Speed range	RPM	6000	6000	6000	6000
Motor	kW	5,5	7,5	7,5	11
Weight	kg	2500	4300	4800 / 4300	8500 / 11700
Dimensions	mm	2200x1700x2500	2600x2100x2600	3100x2300x2500	3500x3000x2900 7400x2900x2900

# Style machining center type MC

Best  
Quality

Made in  
EU  
★★★



Style machining centers type MC are high-quality machines, equipped with the simple, intuitive Style control. The accessible Style CNC control come with great functions, such as 3D simulation, 19" touch screen, DxF file import, free contour drawing and much more.

Type MC uses Class C3 tensioned ball-screw spindles, which prevent thermal expansion for high accuracy. The X/Y/Z-axes are directly driven by the axis motors for the best positioning accuracy.

Technical data		MC 350	MC 500	MC 750	MC 1000
X-axis	mm	350	500	760	1000
Y-axis	mm	210	380	440	560
Z-axis	mm	340	400	460	550
Distance spindle nose - table	mm	50-390	150-550	100-560	100-650
Table size	mm	810x250	650x380	900x410	1200x520
T-slots		3x16	18x100x3	16x100x4	16x80/100x5
Max. table load	kg	80	200	350	800
Rapid movement X-axis	m/min	15	24	24	30
Rapid movement Y-axis	m/min	15	24	24	30
IRapid movement Z-axis	m/min	15	24	24	24
Aut. tool changer	pcs.	8	20	16/24	20/24
Spindle taper	BT	30	30	40	40
Max. spindle speed	RPM	8000	12000	8000	10000
Dimensions	mm	1400x1400x2000	1600x2200x2400	2200x2100x2500	3000x2200x3000
Weight	kg	1400	2800	3300	5200

# Jesco precision lathes

Best  
Quality



Jessey Champion



Jessey Major

Jesco manual lathes are made of highest quality and are among the best of their kind.

The machines are supplied with comprehensive standard equipment.

- Fagor digital equipment
- Rapid traverse Z axis (1500mm & 2000mm machine)
- Steady rest
- Rolling centers
- Micrometer stop
- Threading dial
- Quick change tool holders, 6 pcs.
- Work light
- Complete protection covers
- Magnetic footbrake
- CE approved, according to newest standards
- 2 years warranty



Jessey Prince

Technical data		Prince 1330	Champion 1540	Major 1840	Major 1860	Major 2080
Distance btw. centers	mm	750	1000	1000	1500	2000
Spindle bore	mm	35	54	80	80	80
Center height	mm	165	190	228	228	254
Swing over bed	mm	330	390	460	460	510
Swing over gap	mm	510	610	710	710	760
Swing over cross slide	mm	190	240	290	290	340
Width of bed	mm	185	270	345	345	345
Tailstock taper		MK 3	MK 4	MK 5	MK 5	MK 5
Camlock		D 1-4	D 1-6	D 1-8	D 1-8	D 1-8
Speed	no	8 / 105-2000	16 / 25-2000	16 / 20-1600	16 / 20-1600	16 / 20-1600
Inch thread	TPI	0,5-6 (in) 0,45-7	0,2 - 14,0	0,2 - 14,0	0,2 - 14,0	0,2 - 14,0
Motor	kW	2,25	5,5	7,5	7,5	7,5
Weight	kg	750	1350	2050	2300	2850

# Meba twin-column bandsaw type ECO

Best  
Quality

Made in  
EU

★ ★ ★



Eco 410 DGA-2300



Eco 510

**MEBA** bandsaws are known for their incredibly high quality and unique patented double-vice system. Material is always clamped rectangularly and close to the saw blade. An innovative electric ball screw saw feeding system provides ultimate cutting performance and quality while minimizing blade wear. Standard with linear ball guideways to provide solid smooth running, maintenance-free performer.

**MEBA – Power Package:** Lifting and lowering of the saw frame with a frequency regulated lead screw drive, with automatic cutting pressure and feed regulator. Rapid lowering of the saw frame via button until material edge. Standard with frequency regulated AC-drive 15-150 m/min. stepless.

Type Eco is available both as semi- and fully automatic bandsaw.

**G:** Semi-automatic

**DG:** Double-mitre

**A:** Automatic

Art. no.	Type	Round				Rectangle				Motor kW	Speed m/min	Blade size mm	Weight kg
		90°	45° R	45° L	30° R	90°	45° R	45° L	30° R				
31500	Eco 335	335	-	-	-	500x335	-	-	-	3	15 - 150	4400x34x1,1	1020
31501	Eco 335 G	335	330	-	200	500x335	320x335	-	200x335	3	15 - 150	4400x34x1,1	1020
31502	Eco 335 DG	335	330	305	180	500x335	320x335	305x335	170x335	3	15 - 150	4400x34x1,1	1320
31503	Eco 335 A	335	-	-	-	500x335	-	-	-	3	15 - 150	4400x34x1,1	1550
31504	Eco 335 GA	335	330	-	200	500x335	320x335	-	200x335	3	15 - 150	4400x34x1,1	1510
31505	Eco 335 DGA-600	335	330	305	180	500x335	320x335	305x335	170x335	3	15 - 150	4400x34x1,1	2020
31506	Eco 335 DGA-1000	335	330	305	180	500x335	320x335	305x335	170x335	3	15 - 150	4400x34x1,1	2220
31507	Eco 335 DGA-2300	335	330	305	180	500x335	320x335	305x335	170x335	3	15 - 150	4400x34x1,1	2550
31508	Eco 335 DGA-3300	335	330	305	180	500x335	320x335	305x335	170x335	3	15 - 150	4400x34x1,1	2850
31509	Eco 410	410	-	-	-	700x410	-	-	-	5,5	15 - 150	5800x41x1,3	1850
31510	Eco 410 DG	410	410	410	320	700x410	500x410	430x410	320x410	5,5	15 - 150	5800x41x1,3	1850
31511	Eco 410 A-1300	410	-	-	-	700x410	-	-	-	5,5	15-150	5800x41x1,3	2900
31512	Eco 410 DGA-2300	410	410	410	320	700x410	500x410	430x410	320x410	5,5	15 - 150	5800x41x1,3	3210
31513	Eco 410 DGA-3300	410	410	410	320	700x410	500x410	430x410	320x410	5,5	15 - 150	5800x41x1,3	3510
31514	Eco 510	510	-	-	-	700x510	-	-	-	7,5	15 - 150	6100x41x1,3	2050
31515	Eco 510 DG	510	510	430	320	700x500	500x500	430x500	320x500	7,5	15 - 150	6100x41x1,3	2000
31516	Eco 510 DGA-2300	510	510	430	320	700x500	500x500	430x500	320x500	7,5	15 - 150	6100x41x1,3	3410
31517	Eco 510 DGA-3300	510	510	430	320	700x500	500x500	430x500	320x500	7,5	15 - 150	6100x41x1,3	3710

# Meba twin-column bandsaw type E-cut

Best  
Quality

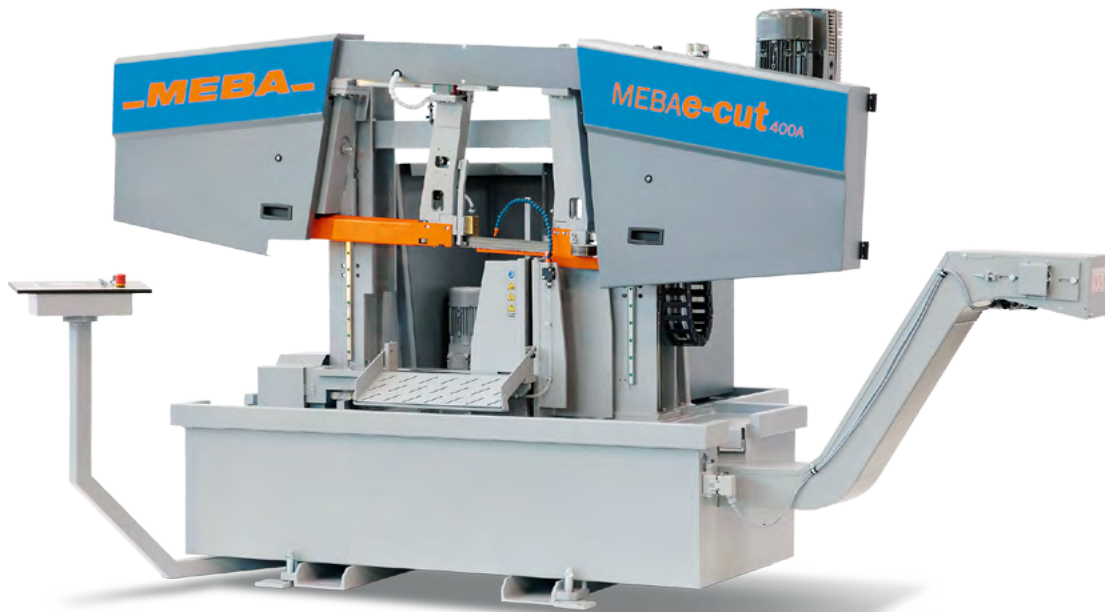

E-cut 400A

**MEBA** bandsaws type E-cut are innovative machines in a very high quality with electric components for a clean and smooth cut.

MEBA – Power Package: Lifting and lowering of the saw frame with a frequency regulated lead screw drive, with automatic cutting pressure and feed regulator. Rapid lowering of the saw frame via button until material edge. Electrical material clamping in main- and infeed vice.

Standard with frequency regulated AC-drive. NC control with user-friendly guide for quick and smooth operation. Movable control panel for flexible usage. An innovative electric ball screw saw feeding system provides ultimate cutting performance and quality while minimizing blade wear. Band wheels are seated on both sides to ensure high stability.



Art. no.	Type	Round				Rectangle				Motor kW	Speed m/min	Blade size mm	Weight kg
		90°	45° R	45° L	30° R	90°	45° R	45° L	30° R				
31520	E-cut 400A	400	-	-	-	500x400	-	-	-	5,5	15 - 150	6220x41x1,3	1950
31521	E-cut 500A	500	-	-	-	500x500	-	-	-	7,5	15 - 150	6220x41x1,3	2150
31522	E-cut 600A	600	-	-	-	600x600	-	-	-	9	15 - 150	7900x54x1,6	2400

# Meba twin-column bandsaw type Xtreme

Best  
Quality

Made in  
EU  
★ ★ ★



Xtreme 800x600



Xtreme 800x600A

**MEBA** bandsaw type Xtreme is a heavy-duty straight cutting bandsaw 90° suitable for more complex jobs. Xtreme is equipped with an extremely rugged and powerful saw blade drive, 67 mm saw blade. Lowerable vice for a smooth and frictionless material handling. Sturdy main clamping vice (double clamping vice). Sensitive saw feed automatic for precise processing.

Linear ball guideways to provide solid, smooth running and maintenance-free performance. Automatic material feed; compact design for short sections and flexible infeed shuttle system for almost any length available. Accurate positioning of the material by servo-positioning technique. Ergonomical panel based on "Windows CE" system software.

Type Xtreme is available both as semi-automatic bandsaw and with NC-control (A).

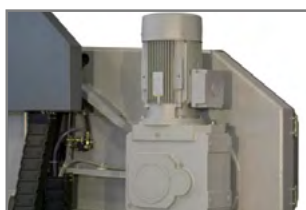

Art. no.	Type	Round	Rectangle	Remaining piece	Remaining piece stack	Shortest diam.	Motor	Speed	Blade size	Weight
		90°	90°	mm (man/aut)	mm (man/aut)	mm Ø	kW	m/min	mm	kg
31530	Xtreme 800x510	510	800x510	22	225	10	14,5	15 - 150	9000x67x1,6	4300
31531	Xtreme 800x510A	510	800x510	22/210	225/380	10	14,5	15 - 150	9000x67x1,6	5300
31532	Xtreme 800x600	600	800x600	22	225	10	14,5	15 - 150	9000x67x1,6	4300
31533	Xtreme 800x600A	600	800x600	22/210	225/380	10	14,5	15 - 150	9000x67x1,6	5600
31534	Xtreme 800x600A-2300	600	800x600	22/210	225/380	10	14,5	15 - 150	9000x67x1,6	6500
31535	Xtreme 800x600A-3300	600	800x600	22/210	225/380	10	14,5	15 - 150	9000x67x1,6	6900
31536	Xtreme 1000x1000	1000	1000x1000	22	225	10	14,5	15 - 150	11045x67x1,6	6500
31537	Xtreme 1140x510	510	1140x510	22	225	10	14,5	15 - 150	9800x67x1,6	4600
31538	Xtreme 1250x510	510	1250x510	22	225	10	14,5	15 - 150	9800x67x1,6	4650
31539	Xtreme 1250x600	600	1250x600	22	225	10	14,5	15 - 150	9800x67x1,6	4650
31540	Xtreme 1250x800	800	1250x800	22	225	10	14,5	15 - 150	10300x67x1,6	6300
31541	Xtreme 1250x1000	1000	1250x1000	22	225	10	14,5	15 - 150	11045x67x1,6	6700

# Meba twin-column bandsaw type MEBAmat

Best  
Quality

Made in  
EU

★ ★ ★



MEBAmat 330

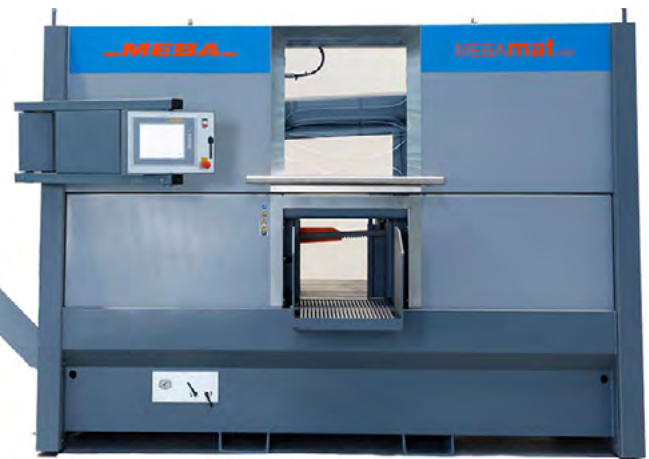

MEBAmat 434

**MEBA** automatic straightcutting bandsaw 90°, suitable for serial cutting. Fully enclosed high performance bandsawing machine for safe, clean, and quiet operation. Practical construction: space saving, easy to access during machine commissioning, saw blade change (large doors) and maintenance activities (inspection openings).

Carbide compatible power-package: sawing of solid material, tubes, and profiles. Trouble-free cutting of hardened material while saving blade life. Maximum, reliable productivity for continuous runs in single- and multi-shift operation. Secure transport of material by closed roller table.

Dynamics and power: saw feed and material feed by ball lead screw with servo-motor for accurate cuts, without compromises. Precision and reliability: use of latest linear ball guideways to provide solid smooth running. Minimum length of remaining piece by innovative vice system.

Intelligent control: networking and communication between drive systems and control unit. Teleservice for remote maintenance. Creations of saw programs in the office. Import of saw programs from CAD with DSTV-interface and data export.

- Hydr. material clamping with full stroke cylinder
- Hydraulic and constant saw blade tension
- Lateral saw blade carbide-roller guidance, preloaded hydraulically
- Clamping rods can be turned around (either ribbed or smooth) on the infeed and main vice
- Inclination of saw blade is at 3°
- Stepless regulation of saw blade speed
- Minimum speed- and saw blade control on the band-wheel
- Hour counter for total-, saw- and order time
- Automatic adjustment of moveable saw blade guidance to material width
- Driven saw blade cleaning brush

**Optional equipment:** Zero positioning, multi-bar/bundle clamp, chip conveyor, aut. material height and width recognition, micro-coolant system, cutting line control, laser light for cutting line, LED working light, waterspray pistol, material database and roller tables

Type	90°	Motor	Speed	Blade size	Remain. piece	Remain. bundle	LxWxH	Working height	Weight
	mm	kW	m/min	mm	mm	mm	mm	mm	kg
330 full automatic	Ø330 350x330	3,9	15 - 200	4900x34x1,1	20	40	2400x1650x2200	750	2600
434 NC automatic	Ø430 430x430	7,5	15 - 150	6220x41x1,3	20	105/210	1700x3100x2350	750	4100

# Manual circular saw type Perfect

Best  
Quality



## PERFECT 250

Manual circular saws, suitable to cut metal profiles and on occasion for solids also from 0° to 45°. Suitable for small workshops. Start button inside the handle. Cooling system with pump and additional filter in the tank. Complete blade guard. Vice with adjustable anti-burr device. Blade spindle 32mm. Adjustable length stop.

## PERFECT 275

Manual circular saws, suitable to cut metal profiles and on occasion for solids also from 0° to 45°. Crown gear/endsless screw in oil bath, single-piece reducer head with external adjustable clutch to safe the gears and blade. Start button inside the handle. Coolant system with pump and additional filter in the tank. Complete metallic blade protection. Vice with adjustable anti-burr device. Blade spindle 32 mm diameter. Adjustable length stop.

## PERFECT 300

Manual circular saws, suitable to cut metal profiles and on occasion for solids also mitre cut from 0° to 45° left and right. Crown gear/endsless screw in oil bath, single-piece reducer head with external adjustable clutch to safe the gears and blade. Start button inside the handle. Coolant system with pump and additional filter in the tank. Complete with metallic blade protection. Vice with adjustable antiburr and quick clamping device. Blade spindle 32mm diameter. Adjustable length stop.

Circular saw type Perfect is delivered standard without blade and base.

Art. no.	Type	Motor	Speed	Blade size	Weight	Cutting Angle	●	■	▣
		kw	m/min	D / d (mm)			mm	mm	mm
31451	PERFECT 250	1 kW	52	250 / 32	73 kg	90° 45°	85 mm	70 mm	95 x 66 mm
		1 kW 0,8 / 1 kW	52 52 / 104				70 mm	60 mm	65 x 50 mm
31453	PERFECT 275	1,1 kW	42	275 / 32	112 kg	90° 45°	90 mm	80 mm	100 x 70 mm
		1,1 / 1,3 kW	33 / 66				70 mm	70 mm	80 x 60 mm
31455	PERFECT 300	1,1 kW 1,5 / 2,0 kW	42 33 / 66	300 / 32	135 kg	90° 45° 45°	102 mm	90 mm	120 x 80 mm
							90 mm	80 mm	90 x 70 mm
							80 mm	70 mm	85 x 70 mm



# Manual circular saw type Record

Best  
Quality

Made in  
EU  
★★★

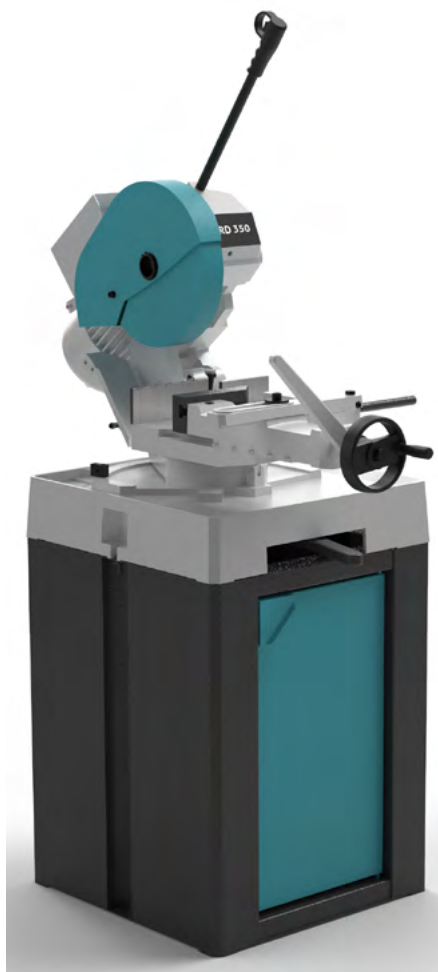

## **RECORD 350**

Manual and powerful circular saw. Mitre cut from 0° to 45° both right and left. Longitudinal cut is possible, thanks to the rotary vice. The machine is suitable for metal profiles and solid steel up to 70 kg / mm.

Rotating head and vice, external adjustable clutch. Crown gear/endless screw in oil bath, with adjustable bearings and elastic coupling.

Start button inside the handle. Main switch, thermic and magnetic motor protection.

Coolant system with pump and additional filter. Handle to rotate the head.

Vice with quick clamping device and adjustable guides. Closing jaw and adjustable anti-burr device to get double clamping with mitre cutting also.

Blade spindle 32mm diameter. Adjustable length stop,

Art. no.	Type	Motor	Speed	Blade size	Weight	Cutting angle	○	□	▣
		kw	m/min	D / d (mm)	kg	°	mm	mm	mm
31457	RECORD 350	1,8 / 2,5 kW	30 / 60	350 / 32	206 kg	90°	125 mm	110 mm	160 x 90 mm
						45°	105 mm	90 mm	80 x 100 mm
						45°	75 mm	65 mm	60 x 70 mm

# Manual circular saw type Sirio 315

Best  
Quality



SIRIO 315



SIRIO 315 SH

## SIRIO 315

Heavy duty manual vertical saw; mitre cutting from 0° to 45° right and from 0° to 60° left.

Suited to cut high-resistance steel. Blade spindle with 40 mm diameter. Vice with adjustable guides, free to move alongside the worktable, with quick motion and clamping, anti-burr adjustable device. Gears with oil, endless screw and bronze crown gear. Easy stops at 0° and 45° left, adjustable length stop.

Floor stand with removable chip collector and coolant tank; coolant electro-pump, main switch, thermic motor protection.

## SIRIO 315 SH

Heavy duty semiautomatic vertical saw; mitre cutting from 0° to 45° right and from 0° to 60° left.

Suited to cut high-resistance steel. Blade spindle with 40 mm diameter. Semiautomatic version with electro-pneumatic functioning, hydraulic control of the down-feed speed of the head and pneumatic vice. Cutting cycles with adjustable feed speed during cut and fast return. Easy regulation of cut start/stop positions by 2 microswitch.

Vice with adjustable guides, free to move alongside the worktable, with quick motion and clamping, anti-burr adjustable device. Gears with oil, endless screw and bronze crown gear. Easy stops at 0° and 45° left, adjustable length stop.

Floor stand with removable chip collector and coolant tank; coolant electro-pump.

Art. nr.	Type	Motor	Speed	Blade size	Weight	Cutting angle	○	□	▣
		kw	m/min	D / d (mm)	kg	°	mm	mm	mm
31460	SIRIO 315	1,5 / 1,8 kW	17 / 33	315 / 40	327 kg 360kg (SH)	☐ 90°	108 mm	93 mm	150 x 90 mm
31461	SIRIO SH	1,5 / 1,8 kW	33 / 66			☐ 45°	108 mm	93 mm	105 x 80 mm
						☐ 60°	93 mm	80 mm	75 x 90 mm
						☐ 45°	108 mm	93 mm	105 x 80 mm

# Automatic circular saw type Sirio 370

Best  
Quality



SIRIO 370 AF-E

Automatic vertical column circular saw, mitre cut from 0° - 45° right (Only in semiautomatic mode) and 0° - 60° to the left. Suitable for high-strength steel. With electronic variable speed, which makes it suitable for cutting in all materials. Blade spindle 40mm. Blade cleaning nylon brush. Vice with adjustable guides with free movement across the full width, fast-moving and clamping, Anti-burr adjustable vice, gear in oil, endless screw and bronze crown gear. Easy stop at 0° and 45° to the left. Adjustable length stop. Base with chip tray that can be emptied and tank with cooling pump, main switch and motor thermal protection. Electro - pneumatic functions hydraulic control of the feed rate.

## SIRIO 370 AF-E

Automatic, vertical column circular saw; mitre cutting from 0° to 45° right (only semiautomatic cycle) and from 0° to 60° left. Suited to cut high-resistance steel, the version with electronic Inverter widens the cutting possibilities, from stainless steel to brass and copper. Primary transmission with pulleys and cogged belt, final reduction in oil bath with big-size bronze crown gear. Vice with adjustable guides, free to move alongside the worktable, with quick motion and clamping; anti-burr adjustable device, pneumatic vertical vice.

Blade spindle with 40 mm diameter. Electronic driver with programming of all operations by means of the keyboard, including setting of the start-cut and end-cut points; machine status shown on display.

Feeder with 200 mm opening, maximum stroke 520 mm, minimum stroke 4 mm (minimum scrap-end 170 mm); selection of the number of cuts (1-9999) and the feeder strokes (1- 29) by means of the keyboard

## SIRIO 370 AF-NC

Automatic CNC vertical column circular saw; mitre cutting from 0° to 45° right (only semiautomatic cycle) and from 0° to 60° left. Suited to cut high-resistance steel, the version with electronic Inverter widens the cutting possibilities, from stainless steel to brass and copper. Primary transmission with pulleys and cogged belt, final reduction in oil bath with big-size bronze crown gear. Vice with adjustable guides, free to move alongside the worktable, with quick motion and clamping; anti-burr adjustable device, pneumatic vertical vice. Blade spindle with 40 mm diameter. Electro-pneumatic driven functioning, hydraulic control of the down-feed speed of the head. Feeder movements by electric motor with encoder, 200 mm. opening, minimum stroke 4 mm. (minimum scrap-end 170 mm.), maximum stroke 520 mm. Up to 99 programs can be memorized, each one with different cutting lengths and number of cuts.

Art. no.	Type	Motor	Speed	Blade size	Weight	Cutting angle	○	□	▣
		kw	m/min	D / d (mm)	kg	°	mm	mm	mm
31464	SIRIO 370 AF-E	1,5 / 2,0 kW 3,0 kW	15 - 30 15 - 70	370 / 40	710 kg	☐ 90°	120 mm	100 mm	180 x 100 mm
						☐ 45°	120 mm	100 mm	130 x 100 mm
						☐ 60°	110 mm	90 mm	90 x 100 mm
31465	SIRIO 370 AF-NC	1,5 / 2,0 kW 3,0 kW	15 - 30 17 - 70		737kg	☐ 45°	105 mm	100 mm	130 x 100 mm

# Manual circular saw type Velox 350

Best  
Quality

Made in  
EU  
★★★



VELOX 350

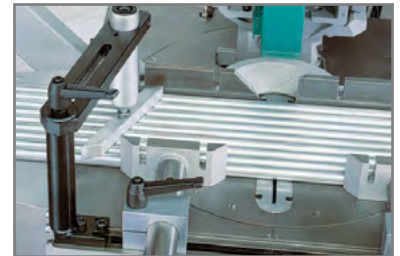

## VELOX 350

**Manual circular saw to cut aluminium and light metals. Mitre cutting from 0° to 45° left and right. The head bends 45° on the vertical axis to allow inclined cuts**

- Mitre cut from 0 - 45° left and right.
- Head rotates 45° in the vertical axis.
- Easy stops at 0°, 15°, 30° and 45° right and left.
- Hand wheel to lock head at any angle.
- Scale engraved in the table.
- 2 vices with quick tension
- Vices run sideways across the width of the table.
- Replaceable jaws on vices.
- 3 phase 2 speed motor allows to run with HSS blades for brass and copper.
- 24V control voltage with start button inside the handle.
- Complete circular saw blade guard.
- Dust extractor can be added.
- Base with tank for cooling pump (optional).
- Delivered standard without blade and base

Art. no.	Type	Motor	Speed	Blade size	Weight	Cutting angle	○	□	▣
		kw	o/min	D / d (mm)	kg	°	mm	mm	mm
31470	VELOX 350	1,3 kW 1,5 / 1,8 kW	3600 1800 / 3600	350 / 32	163 kg	<input type="checkbox"/> 90° <input checked="" type="checkbox"/> 45° <input checked="" type="checkbox"/> 45° <input checked="" type="checkbox"/> 45°	120 mm	105 mm	200 x 80 mm
							115 mm	100 mm	150 x 80 mm
							115 mm	100 mm	150 x 80 mm
							65 mm	60 mm	180 x 50 mm

# Semi-automatic circular saw type Velox 350SH-E

Best  
Quality

Made in  
EU  
★ ★ ★

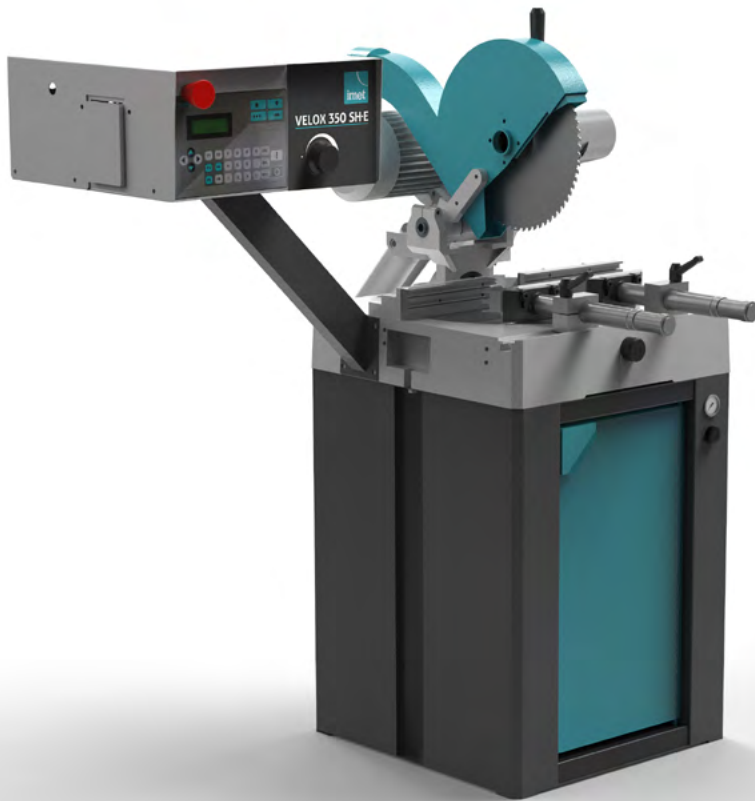

VELOX 350 SH-E

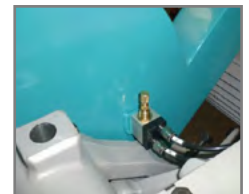

## **VELOX 350 SH-E**

Semi-automatic circular saw suited to cut aluminium and light metals solid and profiles with high accuracy. Possibility to set the machine for brass and copper profiles. Programming of all operations by the keyboard, including setting of the start-cut and end-cut points; machine status shown on display.

- Mitre cut from 0 - 45° left and right.
- Head rotates 45° in the vertical axis.
- Easy stops at 0°, 15°, 30° and 45° right and left.
- Hand wheel to lock head at any angle.
- Scale engraved in the table.
- Programming of all operations by keyboard
- 2 pneumatic vices with quick tension
- Vices run sideways across the width of the table.
- Replaceable jaws on vices.
- Complete circular saw blade guard.
- Dust extractor can be added.
- Delivered standard without blade and base
- Base with tank for cooling pump as optional

Art. no.	Type	Motor	Speed	Blade size	Weight	Cutting angle	○	□	▭
		kw	o/min	D / d (mm)	kg	°	mm	mm	mm
31472	VELOX 350 SH-E	1,5 / 1,8 kW	1800 / 3600	350 / 32	266 kg	□ 90°	120 mm	105 mm	200 x 80 mm
						▤ 45°	115 mm	100 mm	150 x 80 mm
						▥ 45°	115 mm	100 mm	150 x 80 mm
						▧ 45°	65 mm	60 mm	180 x 50 mm

# Automatic circular saw type Velox 350AF

Best  
Quality



VELOX 350 AF-NC



VELOX 350 AF-E

Automatic circular saw for cutting aluminum and other light metals, with the possibility of cutting brass and copper. Mitre cut from 0°-45° right and left. Head can rotate 45° in the vertical axis. Easy stops at 0, 15°, 30° and 45° right and left. Hand wheel to lock head at any angle. Scale engraved in the table. Suitable for cutting profiles and massive with high accuracy.

## VELOX 350 AF-E

The head bends 45° on the vertical axis to allow inclined cuts. Electro-pneumatic functioning. Hydraulic control of the down-feed speed of the head. Electronic driver with programming of all operations by the keyboard. Manual selection of the cutting length with digital reading and decimal nonius. Pair of front pneumatic vices with quick clamping, free to move alongside the worktable, vertical pneumatic vice. Feeder with 200 mm opening, maximum stroke 520 mm, minimum stroke 4 mm (minimum scrap-end 355 mm); selection of the number of cuts (1-9999) and the feeder strokes (1-29) by means of the keyboard. Cast iron head avoids vibrations. Additional vertical pneumatic vice guarantee a perfect material locking.

## VELOX 350 AF-NC

The head bends 45° on the vertical axis to allow inclined cuts. Electro-pneumatic functioning, hydraulic control of the down-feed speed of the head. Feeder with 200 mm opening, moving by electronic motor with inverter. Minimum stroke 4 mm (minimum scrap-end 355 mm). Up to 99 programs can be memorized, each one with different cutting lengths and number of cuts. Programming of all operations by CNC control board easy to use complete display that shows machine status and anomalies. Cast iron head avoids vibrations. Additional vertical pneumatic vice guarantee a perfect material locking.

Circular saw type Velox is delivered standard without blade.

Art. no.	Type	Motor	Speed	Blade size	Weight	Cutting angle	○	□	▭
		kw	m/min	D /d (mm)	kg	°	mm	mm	mm
31473	VELOX 350 AF-E	2,2 kW	3600	350 / 32	585 kg	90°	120 mm	105 mm	200 x 80 mm
	45°					115 mm	100 mm	150 x 80 mm	
	45°					115 mm	100 mm	150 x 80 mm	
31474	VELOX 350 AF-NC				607 kg	45°	65 mm	60 mm	180 x 50 mm

# Manual or GH Bandsaws type GBS & BS

Best  
Quality



BS 400 GH



GBS 242

Manual bandsaws or with gravity lowering mitre cutting from 0° to 60° left and some models from 0° to 45° right. Cast iron sawframe inclined to 42°, in order not to strain the blade excessively. These band saws are suitable for the maintenance and for small productions of section bars, tubes and solids, and for small and medium batch production, mechanics or light steelwork.

## Various features for the manual and GH bandsaws respectively:

- Vice with quick clamping. Easy stops at 0°, 45° and 60° left, graduated plate to identify different angles.
- Vice with adjustable guides, free to move alongside the worktable with fast clamp.
- Adjustment of the blade tension from the front side of the sawframe, checked by an end-stroke.
- Band guides with bearings for blade alignment, pulleys from 260 mm to 360 mm diameter.
- Start-button inside the handle. Warning light for the correct functioning.
- Low voltage coil or minimum tension coil for thermic & magnetic protection.
- Removable coolant tank and electro-pump.
- Floor stand with door and room inside.
- Autocut GH version with "3 ways" selector:
  - A - Manual cut
  - B - Rapid approaching to material
  - C - Automatic cut with adjustable down-feed rate and stop at the end of the cut. The user can move manually the sawframe close to the material, then let the machine make the cut adjusting only the down-feed rate. Manual lift of the sawframe after the cut. Adjustable length stop.

BS 350/400 GH are merely autocut bandsaws, mitre cutting from 0° to 60° left and from 0° to 45° right. Steel sawframe with tubular section, pulleys 360 mm diameter.

- Connection for loading table equipped with roller, 400 mm wide.
- Slide on the unloading side which can be transformed in connection for unloading table.
- Adjustable bar stop, blade-cleaning brush, bi-metal blade.
- Control box with main switch

# Manual or GH Bandsaws type GBS & BS

Best  
Quality

Standard and optional features for the GBS and BS bandsaws respectively:

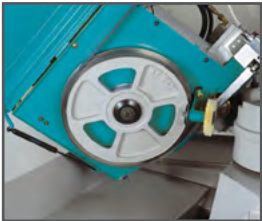

Blade cleaning brush  
BS 350

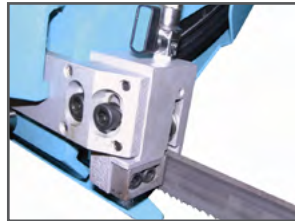

Blade guides with hard  
metal pads

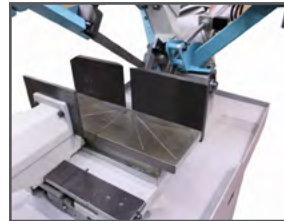

GBS 270 work table



Minimal lubrication



Rapid vice



Pneumatic vice



Springs for perfect  
balance of the saw frame



BS 300 inverter

Art. no.	Type	Function	Suitable for material	Angular cut	Cutting capacity 90° round/square/rect.	Blade size	Motor	Blade speed	Dimension WxLxH	Height worktable	Weight
					mm	mm	kW	m/min.	mm	mm	kg
31600	GBS 185	manual	steel/cast iron/alu	L: 0-45-60°	185/180/200x150	2080x20x0,9	0,8	30/60	600x1200x1700	900	205
31601	GBS 185 GH	man/gravity	steel/cast iron/alu	L: 0-45-60°	185/180/200x150	2080x20x0,9	0,8	30/60	600x1200x1700	900	215
31602	GBS 218	manual	steel/cast iron/alu	L: 0-45-60°	220/210/250x110	2450x27x0,9	1,2	35/70	680x1400x1800	900	240
31603	GBS 218 GH	man/gravity	steel/cast iron/alu	L: 0-45-60°	220/210/250x110	2450x27x0,9	1,2	35/70	680x1400x1800	900	240
31604	GBS 240 GH	man/gravity	steel/cast iron	L: 0-45-60°	240/230/270x230	2700x27x0,9	1,2	35/70	680x1400x1800	900	260
31605	GBS 242 GH	man/gravity	steel/cast iron	L: 0-45-60° R: 0-45°	250/210/290x210	2695x27x0,9	1,1/1,3	35/70	1500x1250x1700	940	290
31606	GBS 270 GH	man/gravity	steel/cast iron	L: 0-45-60° R: 0-45°	270/250/300x150	2920x27x0,9	1,5/1,8	35/70	900x1700x1860	970	330
31607	BS 300/60	manual	steel/cast iron	L: 0-45-60°	255/240/300x180	2765x27x0,9	1,5/1,8	35/70	900x1700x1860	940	290
31608	BS 300/60 GH	man/gravity	steel/cast iron	L: 0-45-60°	255/240/300x180	2765x27x0,9	1,5/1,8	35/70	900x1700x1860	940	310
31609	BS 300 PLUS	manual	steel/cast iron	L: 0-45-60° R: 0-45°	255/240/300x180	2765x27x0,9	1,5/1,8	35/70	900x1700x1860	950	330
31610	BS 300 PLUS GH	man/gravity	steel/cast iron	L: 0-45-60° R: 0-45°	255/240/300x180	2765x27x0,9	1,5/1,8	35/70	900x1700x1860	950	350
31611	BS 350 GH	man/gravity	steel/cast iron	L: 0-45-60° R: 0-45°	305/260/350x200	3370x27x0,9	1,5/2,2	37/74	1480x1700x1900	940	610
31612	BS 400 GH	man/gravity	steel/cast iron	L: 0-45-60° R: 0-45°	310/280/400x200	4020x34x1,1	1,5/2,2	37/74	1530x1790x2240	940	640



# Semi-automatic Bandsaws type BS & KS

Best  
Quality



BS 400 SHI



KS 620

Hydraulic semi-automatic bandsaw, mitre cutting up to 60° left and 60° right, also for high resistance material. Cast iron sawframe with tubular section, pulleys from 320 mm diameter. BS 400 SHI and type KS are with steel sawframe with tubular section, pulleys 360 and 520 mm diameter.

Type KS 450 / KS 450 FT are suitable to cut structural steel, pipes, profiles and beams, type KS 620 medium and big size pipes and profiles. KS is with mitre cutting up to 60° left and right, with easy stops.

## Various features for the BS and KS semi-automatic bandsaws respectively:

- Easy stops at 0°, 45°, 60°.
- Blade guard which allows an easy and quick replacement of the blade.
- Very high blade tension 1700kg / cm<sup>2</sup> with easy regulation from the front side of the sawframe, checked by an end-stroke.
- Blade guides with hard metal pads, additional bearing for blade alignment.
- Hydraulic vice with adjustable guides, free to move alongside the worktable, with quick motion and clamping. BS 300/60 SHI is with manual vice with quick clamping.
- Regulation of the start & end cut point through microswitch (position sensor).
- Thermic and magnetic main switch with minimum tension coil, emergency button, LED for control of functioning.
- Base with coolant tank and electro-pump.
- BS 400 SHI has a wide working space with rotating table integral with the saw frame to avoid incisions of the table, rotation on thrust ring with pre-loaded thrust bearing.
- Frontal console with 3-ways selector to choose different working modalities: the return of the sawframe with steady blade, or end at the cutting cycle without the return of the sawframe. KS 450/620 is equipped with mobile console.
- As optional for some of the bandsaws you can get removable chip collector tank in floor base. Removable tank with coolant electro-pump, hydraulic unit with oil. Washing gun for cleaning and motorised blade-cleaning brush and bi-metal blade.

# Semi-automatic Bandsaws type BS & KS

Best  
Quality

Standard and optional features for the BS and KS bandsaws respectively:

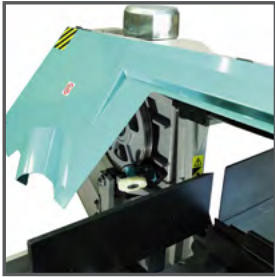

Nylon clean blade brush for type KS

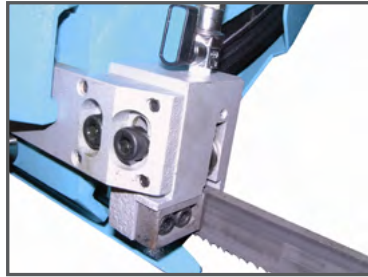

Blade guides with hard metal pads



Mobile console



Position sensor BS 350

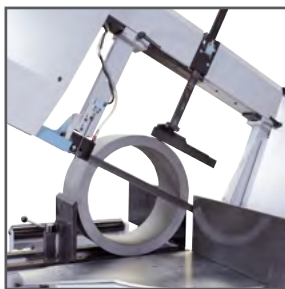

Sensor device for type KS



Hydraulic vertical vice

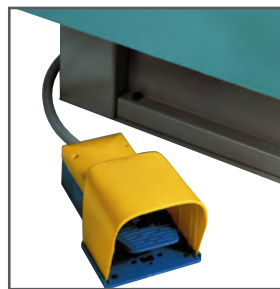

Foot pedal



Minimal lubrication

Art. no.	Type	Function	Suitable for material	Angular cut	Cutting capacity 90° round/square/rect.	Blade size	Motor	Blade speed	Dimension WxLxH	Height worktable	Weight
					mm	mm	kW	m/min.	mm	mm	kg
31620	BS 300/60 SHI	semi-aut/ hydraulic	steel/ cast iron	L: 0-45-60°	255/240/300x180	2765x27x0,9	1,5/1,8	35/70	1050x1700x1860	940	320
31621	BS 300 PLUS SHI	semi-aut/ hydraulic	steel/ cast iron	L: 0-45-60° R: 0-45°	255/240/300x180	2465x27x0,9	1,5/1,8	35/70	1230x1700x1750	940	415
31622	BS 350 SHI	semi-aut/ hydraulic	steel/ cast iron	L: 0-45-60° R: 0-45°	305/260/350x200	3370x27x0,9	1,5/2,2 or 2,2 ESC	37/74	1480x1750x1900	940	650
31623	BS 400 SHI	semi-aut/ hydraulic	steel/ cast iron	L: 0-45-60° R: 0-45°	310/280/400x250	4020x34x1,1	1,5/2,2 or 2,2 ESC	37/74	1530x1790x2240	940	680
31624	KS 450 FT	semi-aut	steel/alu/ cast iron	L: 0-45-60° R: 0-45-60°	350/330/450x320	4250x34x1,1	1,7/2,2 or 2,2 ESC	35/70 or 15 ÷ 100 ESC	900x2500x2180	850	865
31625	KS 450	semi-aut	steel/alu/ cast iron	L: 0-45-60° R: 0-45-60°	350/330/450x320	4250x34x1,1	1,7/2,2 or 2,2 ESC	35/70 or 15 ÷ 100 ESC	900x2500x2180	850	865
31626	KS 620	semi-aut	steel/ cast iron	L: 0-45-60° R: 0-45-60°	500/420/600x400	5320x34x1,1	3	15 ÷ 100	1740x2500x2500	805	1450

# Automatic Bandsaws type AFI / CUBO

Best  
Quality

Made in  
EU  
★★★



BS 350/60 AFI-NC



CUBO 300 NC-FLAT

Fully automatic bandsaws with mitre cutting from 0° to 60° left.  
The CUBO 300 models cut from 0° to 45° in automatic cycle and 0° to 60° in semi-automatic cycle.  
Cast iron sawframe with tubular section with electronic inverter for variable blade speed.

## Various features for the automatic bandsaws:

- Adjustment of the blade tension from the front side of the sawframe, checked by an endstroke.
- Blade guides with hard metal pads, additional bearing for blade alignment.
- Maximum single stroke 515 mm, minimum stroke 4 mm, selection of the number of cuts (1-9999) and feeder strokes (1-29) by means of the keyboard.
- Feeder movements on chrome bars, high-precision of the positioning due to the incremental feeding on recirculating ball screw by self-bracking electric motor with inverter. Automatic calculation of the blade thickness.
- Manual selection of the cutting length and number of cuts on electronic versions with digital reading and decimal accuracy.
- Hydraulic fixed vice with pressure reducer, anti-burr hydraulic vertical vice on the unloading side.
- PLC driver with programming of all operations by means of the keyboard.
- Position sensor.
- Easy stops at 0°, graduated plate to identify different angles
- CNC with programming of all operations; automatic calculation of the blade thickness. Up to 99 programs with 10 different cutting lengths and number of cuts can be memorized, with the possibility to repeat them more than once.
- Machine status shown on display, including blade speed, piece counter, and working anomalies. Connection for loading table with 2 vertical rollers, unloading slide, connection for unloading table for cutting pieces.
- Main switch with minimum tension coil, emergency button, thermic and magnetic motor protection.

# Automatic Bandsaws type AFI / CUBO

Best  
Quality

## Standard and optional features for the AFI bandsaws:



Minimal lubrication



Bundle cutting



Hydr. device for bundle cutting



Hydr. unit and electrical panel



Screw feeder in all automatic NC bandsaws

Art. no.	Type	Feeder opening	Motor hydraulic unit	Tank cap. hydr. unit	Capacity coolant tank	Min. cuttable length	Scrap end
		mm	kW	litres	litres	mm	mm
31630	CUBO 300-E-FLAT	300	0,75	20	100	4	210
31631	CUBO 300 NC-FLAT	300	0,75	20	100	4	210
31633	BS 350/60 AFI-NC	350	0,75	20	100	4	80
31634	BS 400/60 AFI-E	400	0,75	20	100	4	80
31635	BS 400/60 AFI-NC	400	0,75	20	100	4	80



Keyboard for CNC automatic bandsaw

Art. no.	Type	Function	Suitable for material	Angular cut	Cutting capacity 90° round/square/rect.	Blade size	Motor blade power	Blade speed	Dimension WxLxH	Height worktable	Weight
					mm	mm	kW	m/min.	mm	mm	kg
31630	CUBO 300-E-FLAT	semi-aut/automatic	steel/cast iron/high-strength steels	L: 0-45-60°	255/230/300x180	2765x27x0,9	1,5/1,8 or 1,5 ESC	35/70 or 18 ÷ 110 ESC	1800x1850x1880	870	630
31631	CUBO 300 NC-FLAT	semi-aut/aut. CNC	steel/cast iron/high-strength steels	L: 0-45-60°	255/230/300x180	2765x27x0,9	1,5/1,8 or 1,5 ESC	35/70 or 18 ÷ 110 ESC	1800x1850x1880	870	680
31633	BS 350/60 AFI-NC	semi-aut/aut. CNC	steel/cast iron/high-strength steels	L: 0-45-60°	305/250/350x200	3370x27x0,9	1,8	18 ÷ 110	1850x1900x1990	880	890
31634	BS 400/60 AFI-E	semi-aut/automatic	steel/cast iron/high-strength steels	L: 0-45-60°	310/280/400x250	4020x34x1,1	2,2	18 ÷ 110 ESC	1850x2200x1990	890	940
31635	BS 400/60 AFI-NC	semi-aut/aut. CNC	steel/cast iron/high-strength steels	L: 0-45-60°	310/280/400x250	4020x34x1,1	2,2	18 ÷ 110	1850x2200x1990	890	990

# Semi-automatic Bandsaws type H

Best  
Quality

Made in  
EU  
★★★



Semi-automatic twin column bandsaws, hydraulically driven.

H601 is for mitre cutting with variable angle up to 60° to the left, with the manual shifting of the saw frame. H700, H800, H820 and H1200 are for straight cut only. Especially suitable for cutting profiles, pipes, beams and also solids.

## Various features for the semi-automatic bandsaws:

- Steel sawframe with tubular section; worktable supported by a central pivot with preloaded bearings.
- Sawframe movement onto an electro-welded column of big dimension, with two recirculating ballscrews and linear guides.
- Long-Life monobloc motoreducer.
- Registrable band guides with hard metal pads and guided bearings.
- Electronic inverter for variable blade speed.
- Automatic control of the beginning and end cut through a feeler pin; regulation of the descent of the arch and strength of the penetration through the console.
- Mechanical tensioning of the blade with a control micro-switch.
- Sawframe canted 5° allows sawblade to freely and easily cut through the bottom of structural section without vibration, binding, or slowdown of sawing rates.
- "Clean cut" due to the standard cooling system with minimal lubrication to cut long pipe and profile without any leakage of coolant.
- Motorized blade-cleaning brush and floor stand with removable chip collector.
- Hydraulic unit with oil, capacity 20 litres, motor 0,75 / 1 kW.
- Lockable main switch, tension coil, thermic and magnetic protection, emergency button, sensors for closing the guard, tension blade and motor overload.

# Semi-automatic Bandsaws type H

Best  
Quality

## Standard and optional features for the semi-automatic bandsaws type H:



Minimal lubrication

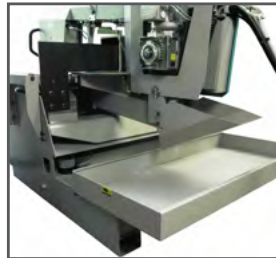

Wide chip collector



Pulleys H 601



Mobile console



Blade tensioning KTECH via electro-mechanical system, CNC-controlled



Roller tables, also in motorised and vertical versions



Mobile blade guide automatically kept in contact with the cutting point by means of a gas piston

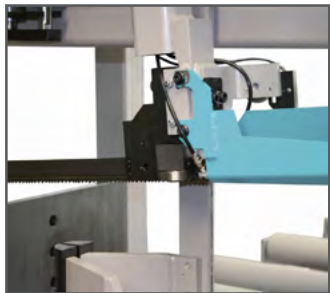

Art. no.	Type	Suitable for material	Angular cut	Cutting capacity 90° round/square/rect. mm	Cutting capacity 90° rect. w.bundle cutting mm	Blade size mm	Motor blade power kW	Blade speed m/min.	Dimension WxLxH mm	Height worktable mm	Weight kg
31650	H 601	steel/cast iron/high-strength steels/alloys	L: 0-45-60°	510/480/610x450	600x250 max. 150x50 min.	5320x34x1,1	3	15 ÷ 100	1500x2850x2170	820	1700
31651	H 700	steel/cast iron/high-strength steels/alloys	90°	520/450/680x400	500x400	5870x34x1,1	3	15 ÷ 100	1100x3300x2500	840	1900
31652	H 800	steel/cast iron/high-strength steels	90°	680/640/820x610	800x350	7260x41x1,3	5,5	15 ÷ 100	1550x3600x2700	800	3100
31653	H 820	steel/cast iron/high-strength steels	90°	810/740/810x740	-	7575x41x1,3	4	15 ÷ 100	1100x3375x3100	890	2300
31654	H 1200	steel/cast iron/high-strength steels	90°	680/640/1200x600	1000x350	8140x54x1,6	7,5	15 ÷ 90	1450x4000x2750	855	940

# Automatic Bandsaws type H

Best  
Quality



Automatic CNC twin column bandsaws, hydraulically driven.

H 601 NC mitre cutting up to 60° to the left, with the manual shifting of the saw frame. Especially good for cutting sections of steelwork, tubes and solids.

H700/H800/H1200 NC are for straight cut only, with hydraulic lowering of the bow, especially suited for cutting profiles, structural steel work, beams, tubes and also solids.



## Various features for the automatic bandsaws:

- Steel sawframe with tubular section; worktable supported by a central pivot with preloaded bearings.
- Sawframe movement onto an electro-welded column of big dimension, through two recirculating ballscrews and linear guides.
- Long-Life monobloc motoreducer.
- Registrable band guides with hard metal pads and guided bearings.
- Feeder 550 mm long with electric movement through recirculating ballscrews diam. 32 mm onto linear guides. Both feeder jaws open to load bars which are not perfectly straight.
- Hydraulic frontal vices.
- Minimal scrap-end H601 NC: 100 mm, H700/H800/H1200: 175 mm.
- Electronic inverter for variable blade speed.
- Automatic control of the beginning and end cut through a feeler pin; regulation of the descent of the arch and strength of the penetration through the console.
- Mechanical tensioning of the blade with a control micro switch. Canted blade 6°.
- CNC driver allows to set and memorize up to 99 cutting programs, with 10 different cutting lengths and quantities. Type H700/H800/H1200 can memorize up to 300 cutting programs.
- CNC keyboard placed onto a mobile console.
- Connections for attaching roller table.
- Motorized blade-cleaning brush and floor stand with removable chip collector and feeder holder cover made of electrowelded steel.
- Tension of the blade 2300 kg/cm<sup>3</sup>.
- Hydraulic unit with oil, capacity 20 litres, motor 0,75 / 1,5 kW.
- "Clean cut" due to the standard cooling system with minimal lubrication to cut long pipe and profile without any leakage of coolant.
- Coolant tank with electro-pump, capacity 100 litres.
- Lockable main switch, tension coil, thermic and magnetic protection, emergency button, sensors for closing the guard, tension blade, motor overload and bi-metal blade.

# Automatic Bandsaws type H

Best  
Quality

## Standard and optional features for the automatic bandsaws type H:



Minimal lubrication

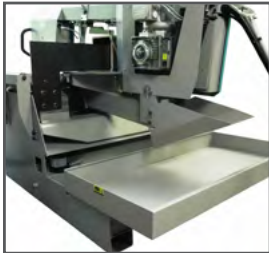

Wide chip collector



Pulleys H 601



Control panel H 601 NC

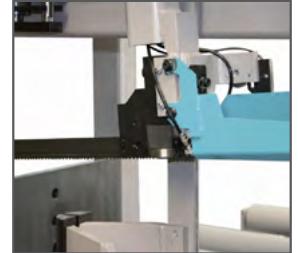

Mobile blade guide automatically kept in contact with the cutting point by means of a gas piston



Blade tensioning KTECH via electro-mechanical system, CNC-controlled



Digital reader with large LCD screen



Roller table mounted on H 700 NC



Screw feeder - in the automatic NC bandsaws the movement of the feeder is via a recirculating ballscrew and gear motor controlled by an inverter

Art. no.	Type	Suitable for material	Angular cut	Cutting capacity 90° round/square/rect. mm	Cutting capacity 90° rect. w.bundle cutting mm	Blade size mm	Motor blade power kW	Run feeder carriage repeatable mm	Blade speed m/min.	Dimension WxLxH mm	Height work-table mm	Weight kg
31655	H 601 NC F 500	steel/cast iron/high-strength steels	L: 0-45-60°	510/480/610x450	600x250 max. 150x50 min.	5320x34x1,1	3	550	15 + 100	2650x2800x2170	820	2300
31656	H 700 NC F 1500	steel/cast iron/high-strength steels/alloys	90°	520/450/680x400	500x400	5870x34x1,1	3	1500	15 + 100	5400x3300x2500	900	2900
31657	H 700 NC F 3000	steel/cast iron/high-strength steels/alloys	90°	520/450/680x400	500x400	5870x34x1,1	3	3000	15 + 100	5400x3300x2500	900	2900
31658	H 800 NC F 1500	steel/cast iron/high-strength steels	90°	680/640/820x610	800x350	7960x41x1,3	5,5	1500	15 + 100	5850x3600x2700	820	4460
31659	H 800 NC F 3000	steel/cast iron/high-strength steels	90°	680/640/820x610	800x350	7960x41x1,3	5,5	3000	15 + 100	5850x3600x2700	820	4460
31660	H 1200 NC F 1500	steel/cast iron/high-strength steels	90°	680/640/1250x600	1000x350	8140x54x1,6	7,5	1500	15 + 90	5750x4000x2750	855	4955
31661	H 1200 NC F 3000	steel/cast iron/high-strength steels	90°	680/640/1250x600	1000x350	8140x54x1,6	7,5	3000	15 + 90	5750x4000x2750	855	4955



# Semi-automatic Bandsaws type KS

Best  
Quality

Made in  
EU  
★★★



Semi-automatic CNC twin column bandsaws, hydraulically driven. Type KS allows to cut right and left till 60°. Especially designed for cutting medium and big size pipes and profiles.

## Various features for the semi-automatic bandsaws type KS:

- Steel sawframe with tubular section; worktable supported by a central pivot with preloaded bearings.
- Sawframe movement onto an electro-welded column of big dimension, through two recirculating ballscrews and linear guides.
- Long-Life monobloc motoreducer.
- Registrable band guides with hard metal pads and guided bearings.
- Electronic inverter for variable blade speed.
- Automatic control of the beginning and end cut; regulation of the descent of the arch and strength of the penetration through the console.
- Mechanical tensioning of the blade with a control micro-switch.
- Sawframe canted blade.
- The rotation of the machine is made with geared motor and linear encoder positioned at a high distance from the center of rotation for highest precision in the position with hydraulic locking of the rotation.
- The special section with inclined pulleys ensures a minor twist of the blade extending the life of the tool.
- "Clean cut" due to the standard cooling system with minimal lubrication to cut long pipe and profile without any leakage of coolant.
- Available also with manual rotation of the bow and digital display to show the angle, easy stops at 0° and 45° left and right.
- Hydraulic unit with oil, capacity 20 / 50 litres, motor 0,75 / 1,5 kW depending on type.

# Semi-automatic Bandsaws type KS

Best  
Quality

## Standard and optional features for the semi-automatic bandsaws type KS:



Minimal lubrication

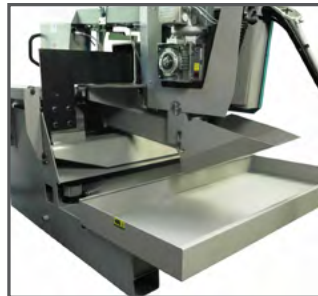

Wide chip collector

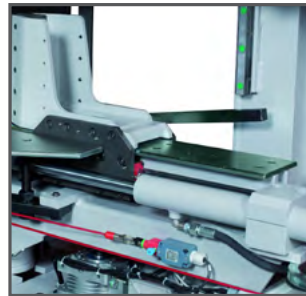

Safety wire detecting obstacles



Mobile console



Digital display showing angle of sawframe

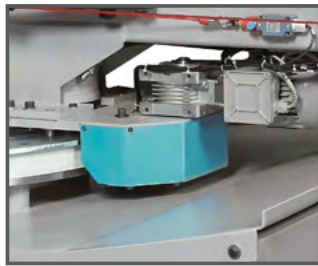

Motoreducer and blocking.

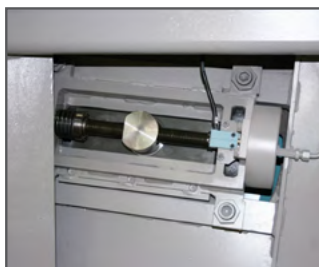

Blade tensioning KTECH via electro-mechanical system, CNC-controlled



Mobile blade guide automatically kept in contact with the cutting point.



KS 802 NC with roller table - various roller tables are available, also in motorised and vertical versions

Art. no.	Type	Suitable for material	Angular cut	Cutting capacity 90° round/square/rect. mm	Cutting capacity 90° rect. w.bundle cutting mm	Blade size mm	Motor blade power kW	Blade inclination °	Blade speed m/min.	Dimension WxLxH mm	Height work-table mm	Weight kg
31663	KS 502	steel/cast iron/high-strength steels/alloys	L: 0-45-60° R: 0-45-60°	350/335/500x325	500x250 max. 160x40 min.	4250x34x1,1	2,2	6	15 ÷ 100	1470x2405x1935	844	1200
31664	KS 702 NC	steel/cast iron/high-strength steels/alloys	L: 0-45-60° R: 0-45-60°	520/450/680x400	-	5870x34x1,1	3	6	15 ÷ 100	1600x3300x2500	900	1950
31665	KS 802 NC	steel/cast iron/high-strength steels/alloys	L: 0-45-60° R: 0-45-60°	680/640/820x610	-	7260x41x1,3	5,5	5	15 ÷ 100	2050x3600x2700	815	3200
31666	KS 1202 NC	steel/cast iron/high-strength steels	L: 0-45-60° R: 0-45-60°	680/640/1250x600	-	8140x54x1,6	5,5	5	15 ÷ 90	1950x4000x2750	855	3600

# Automatic Bandsaws type KTECH

Best  
Quality

Made in  
EU  
★★★

KTECH 502

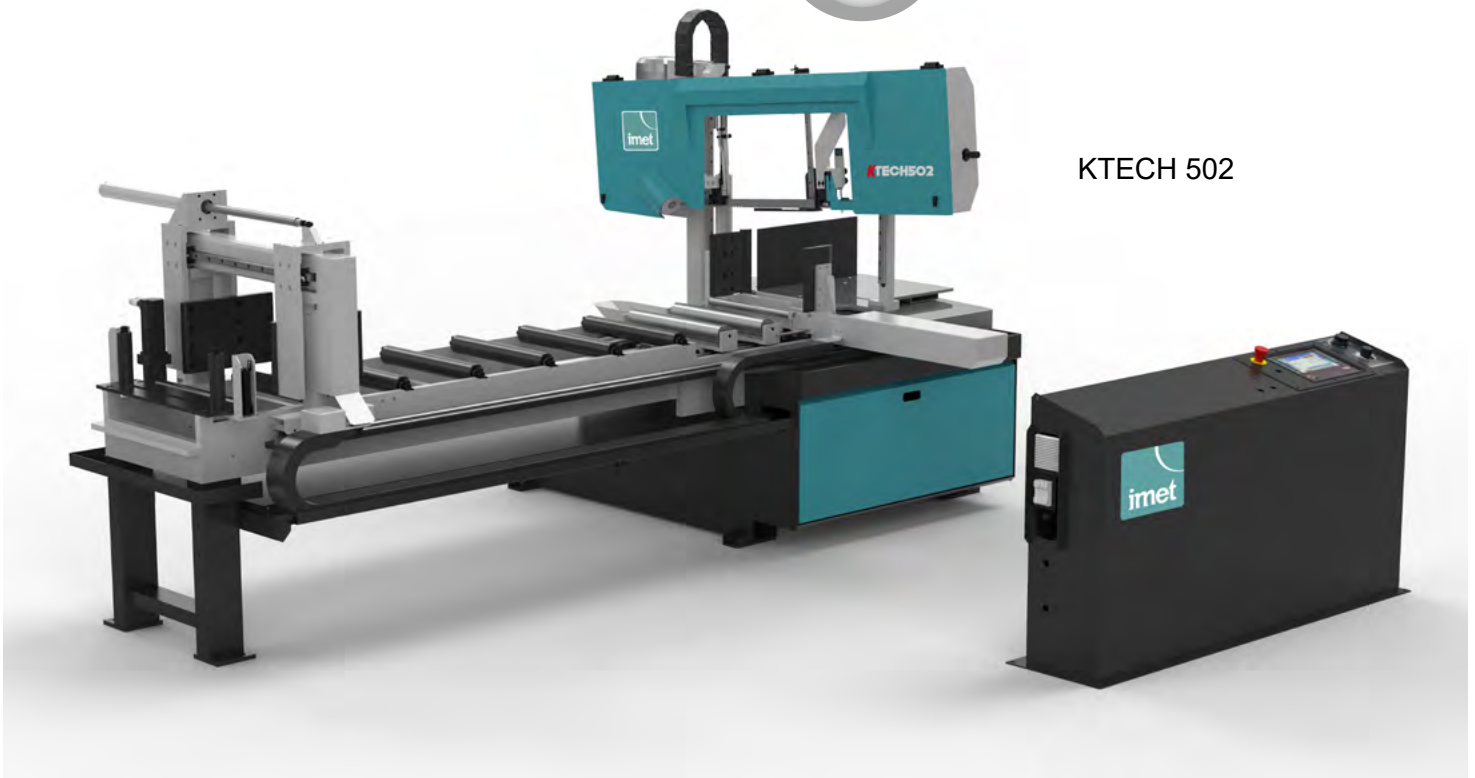

## Various features for the automatic bandsaws type KTECH:

- Steel sawframe with tubular section; worktable supported by a central pivot with preloaded bearings.
- Movements guided by supports on heavy load balls type linear guideway, CNC control for clamps and arch rotation.
- Control of cutting angles by encoder and inverter, optimized selection of cuts via cnc for multiple operations with simple guided programming.
- Integrated keyboard with CNC control on 3 axes, large RAM memory, LCD display for guided setting of cut parts with the necessary angles, possibility of cutting with double angle on one side
- The numerical control with 90 programs, and over 300 cutting programs on KTECH 502.
- Monoblock column and frame with conveyor in an electro-welded solid steel structure. High precision of positioning thanks to the linear hardened guides and the recycling screw.
- Adjustable bearings with conical rollers on a swinging pin. Single-block longlife gearmotor.
- Blade tension 1700 Kg/cm<sup>2</sup> with blade guide runners adjustable with hard metal inserts and guide bearings.
- Adjustment of the force and speed of saw frame descent with separate controls, to adapt the cutting parameters to the type of material.
- Minimal lubrication system as standard.
- End of the cut with tilted blade, ensure better penetration, increased blade life and rapid action.
- “Clean cut” due to standard cooling system with minimal lubrication to cut long pipe and profile without any leakage of coolant.
- Hydraulic unit with low noise pump and locking valves on all the movements, with vice pressure reducers. Most processes are carried out with switched off hydraulic unit that allows a considerable saving of energy and maintains a low oil temperature.

# Automatic Bandsaws type KTECH

Best  
Quality

## Standard and optional features for the automatic bandsaws type KTECH:



Minimal lubrication

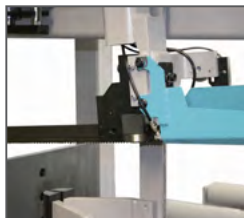

Mobile blade guide automatically kept in



Safety wire detecting obstacles



Blade tensioning KTECH via electro-mechanical system, CNC-controlled



Various roller tables are available, also in motorised and vertical versions

Type	Feeder motor power kW	Motor hydraulic unit kW	Tank cap. hydr. unit litres	Capacity coolant tank litres	Min. cuttable length mm	Scrap end min. mm
KTECH 502 F2000	0,75	0,75	20	3	30	165
KTECH 652 F2000	0,75	3	20	3	30	260
KTECH 802 F3000 / 6000	1,5	1,5	80	3	30	150
KTECH 1202 F3000 / 6000	1,5	1,5	80	3	30	150

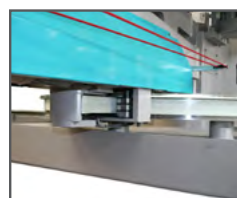

Blocking of the rotation through a hydraulic cylinder

Art. no.	Type	Suitable for material	Angular cut	Cutting capacity 90° round/square/rect. mm	Cutting capacity 90° rect. w.bundle cutting mm	Blade size mm	Motor blade power kW	Run feeder carriage repeatable mm	Blade speed m/min.	Dimension WxLxH mm	Height work-table mm	Weight kg
31667	KTECH 502 F2000	steel/cast iron/high-strength steels	L: 0-45-60° R: 0-45-60°	350/335/500x325	500x250 max. 160x40 min.	4250x34x1,1	2,2	2050	18 ÷ 100	4120x2300x2180	845	2200
31668	KTECH 652 F2000	steel/cast iron/high-strength steels	V: 0-45-60° H: 0-45-60°	510/480/650x450	650x450 max. 125x0 min.	5320x34x1,1	3	2050	18 ÷ 100	3930x2870x2300	845	3550
31670	KTECH 802 F3000	steel/cast iron/high-strength steels/alloys	L: 0-45-60° R: 0-45-60°	680/640/820x610	800x350	7260x41x1,3	4,5	3000	15 ÷ 100	5850x3700x2700	815	4800
31671	KTECH 802 F6000	steel/cast iron/high-strength steels/alloys	L: 0-45-60° R: 0-45-60°	680/640/820x610	800x350	7260x41x1,3	4,5	6000	15 ÷ 100	5850x3700x2700	815	4800
31672	KTECH 1202 F3000	steel/cast iron/high-strength steels/alloys	L: 0-45-60° R: 0-45-60°	680/640/1250x600	800x350	8140x54x1,6	5,5	3000	15 ÷ 90	5750x4200x2750	850	5300
31673	KTECH 1202 F6000	steel/cast iron/high-strength steels/alloys	L: 0-45-60° R: 0-45-60°	680/640/1250x600	800x350	8140x54x1,6	5,5	6000	15 ÷ 90	5750x4200x2750	850	5300

# Automatic Bandsaws type XSMART

Best  
Quality

Made in  
EU



SMART feeder with built-in supporting table



Double vices before and after the band blade, ensuring a perfect clamping of the bar during operation

Automatic hydraulic twin column straight cut bandsaws, for high production series. Advanced robust design, made of electro-welded painted steel, with a removable coolant tank to make the cleaning easier. Sawframe and base made of vibration- and noise-free high-thickness electro-welded steel.

## Various features for the automatic bandsaws type XSMART:

- CNC control for programming multiple lengths and quantities on the same bar.
- Feeder carriage with bridge structure and roller conveyor for material support.
- Material feed by the electric motor and recirculating ballscrews.
- Double vice for clamping the workpiece before and after the blade.
- Pulleys inclination of 30 degrees allows to extend the life of the blade.
- Double column saw frame with sliding of the mobile blade guide on linear guides and recirculating ballscrews, with automatic approach of the workpiece.
- Sensor for automatic detection of the start cut point.
- Standard vice and cutting pressure adjustment.
- Completely covered with easy access for maintenance.
- Mobile console.
- Led light for lighting the working area.
- Electric chips conveyor as optional.
- Washing gun and motorised cleaning brush.

Type	Feeder motor power	Motor hydraulic unit	Tank cap. hydr. unit	Capacity coolant tank	Min. cuttable length	Scrap end min.
	kW	kW	litres	litres	mm	mm
XSMART 3	0,75	0,75	20	50	10	50

Art. no.	Type	Suitable for material	Angular cut	Cutting capacity 90° round/square//rect	Cutting capacity 90° rect. w.bundle cutting	Blade size	Motor blade power	Run feeder carriage repeatable	Blade speed	Dimension WxLxH	Height work-table	Weight
				mm	mm	mm	kW	mm	m/min.	mm	mm	kg
31674	XSMART 3	steel/cast iron/ high-strength steels/alloys	90°	310/310/340x310	340x250	3730x34x1,1	3	500	15 + 100	1950x1755x1965	922	1650

# Automatic Bandsaws type XTECH

Best  
Quality

Made in  
EU  
★★★



XTECH 630

Automatic CNC twin column straight cut bandsaws combining extremely solid mechanical structure and advanced technology to guarantee high production process and high accuracy.

## Various features for the automatic bandsaws type XTECH:

- The special double section allows to support the pulleys from both sides by a couple of big-size bearings.
- The blade guides are equipped with hard metal pads and kept hydraulically in contact with the blade.
- The blade is tensioned by hydraulic cylinder and is controlled by the software of the saw.
- Up to 99 programs with different cutting lengths and quantity can be memorized.
- The blade speed, controlled by electronic inverter, is infinitely variable between 12 and 100 mt/min, allowing to cut efficiently a wide variety of materials.
- It has one system that allows the vices to "back off" to avoid the blade rubbing on the cut surface during the ascent of the sawframe for the following cut.
- The added advantage of this design enables the use of high performance TCT bandsaw blades. Hydraulically pressure of ground TCT blade guides for maximum precision and squareness of cut.
- With the option "Short Batch & 'One Off' Sawing" there is the possibility to cut the material section not completely in automatic cycle.
- Automatic Trim Cut option, if the material has an acceptable pre sawn face, it will be accurately and automatically located relatively near the blade 'zero' position. This feature saves time and cuts down on material wastage.
- A device for checking the accuracy/ squareness of the cut, with automatic adjustment or stopping of the sawframe descent speed in the event of blade deviation.
- Various roller tables are available.

# Automatic Bandsaws type XTECH

Best  
Quality

Standard and optional features for the automatic bandsaws type XTECH:



Minimal lubrication



Mot. chips conveyor,  
hydraulically driven



Detachment of the  
blade



Blade cleaning brush



Electrical board



Bundle cutting



Feeder carriage



CNC with touch screen



Automatic trim cut option



XTECH roller table



Special double section of saw frame

Type	Feeder motor power	Motor hydraulic unit	Tank cap. hydr. unit	Capacity coolant tank	Min. cuttable length	Scrap end min.
	kW	kW	litres	litres	mm	mm
XTECH 630	2,2	2,2	90	320	6	20

Art. no.	Type	Suitable for material	Angular cut	Cutting capacity 90° round/square/rect.	Cutting capacity 90° rect. w.bundle cutting	Blade size	Motor blade power	Run feeder carriage repeatable	Blade speed	Dimension WxLxH	Height work-table	Weight
				mm	mm	mm	kW	mm	m/min.	mm	mm	kg
31677	XTECH 630	steel/cast iron/ high-strength steels/alloys	90°	630/630/630x630	630x500	8200x54x1,6	7,5	500	9 + 90	4100x2250x2500	800	6700

# Automatic Bandsaws type XT

Best  
Quality

Made in  
EU  
★ ★ ★



Automatic CNC double column band saw, flexible and suitable for various sawing needs. Extremely sturdy construction with advanced technology to ensure high production process and high accuracy. Possibility of "Short batch & One Off" sawing, so that you do not cut the material completely into automatic cycle.

Automatic Trim-cut possibility, thus saving time and resources.

## Various features for automatic bandsaw type XT:

- Vertical lowering system
- 10" touch screen - automatic operation so that everybody can operate the machine - just choose type, dimensions and shape of the material
- The software contains more than 100 material parameters divided into 16 different groups
- The saw frame is made from very sturdy electro-welded steel, which guarantees no vibrations and no noise
- The saw frame movement is thoroughly balanced, accomplished by a high performance brushless motor driving a ball recirculating screw
- High precision and short changeover time
- All movements of saw frame, vices, feeder and mobile blade guides are performed by means of ball recirculating guides with high static and dynamic load, ensuring minimized sliding friction values
- At the end of each cutting process, the feeder moves back to detach the material from the blade while the blade is being lifted on the rear side
- Vices on both the front and the rear side of the saw blade ensures perfect clamping of the material
- Software for automatic cuts, stopping at a predefined depth, i.e. without cutting the whole piece
- Blade deviation detection with automatic feeding compensation in case of blade deviation  $\pm 0,2$  mm
- Blade guides with hard metal pads, hydraulically pressed against the blade, controlled by the software of the saw
- If the saw is not operated for some time, the blade is automatically released to avoid unnecessary stress
- In case of blade breakage the cutting cycle is immediately stopped and an emergency is reported in the display



# Automatic Bandsaws type XT

Best  
Quality

## Standard equipment for automatic bandsaw type XT:

- Motorised blade brush
- Feeder electrically driven with rack & pinion transmission
- Lubro-refrigerating system incl. electric pump and shutoff valves
- Automatic blade run-in procedure (30% higher efficiency)
- Electrically driven screw conveyor
- Hydraulic system with steady flow rate pump with drain filter and manometer
- Trim Cut possibility - selected from the keyboard

## Optional equipment for automatic bandsaw type XT:

- Roller tables
- Minimal lubrication
- Bar loader, automatic system with drag chains for 0,5-4 tons load
- Off-line programming - connected through Ethernet for remote assistance and software updates directly from Imet
- Bundle cutting

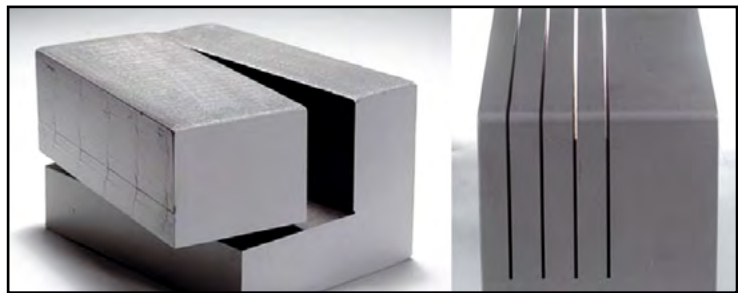

Type	Feeder motor power	Motor hydraulic unit	Tank cap. hydr. unit	Capacity coolant tank	Min. cuttable length	Scrap end min.
	kW	kW	liter	liter	mm	mm
XT 4	1,5	5,5	60	100	6	20
XT 5	1,5	5,5	60	160	6	20
XT 6	1,5	5,5	60	190	6	20

Art. no.	Type	Suitable for material	Angular cut	Cutting capacity 90° round/square	Cutting capacity 90° rect. w.bundle cutting	Blade size	Motor blade power	Run feeder carriage repeatable	Blade speed	Dimension WxLxH	Height work-table	Weight
				mm	mm	mm	kW	mm	m/min.	mm	mm	kg
	XT 4	steel/cast iron/ high-strength steels/alloys	90°	360/360	360x350	5900x41x1,3	3	500	15 + 150	2800x1794x2210	877,5	3500
	XT 5	steel/cast iron/ high-strength steels/alloys	90°	460/460	460x450	6100x54x1,3	5,5	500	15 + 150	3100x1900x2300	870	4300
	XT 6	steel/cast iron/ high-strength steels/alloys	90°	560/560	560x550	7320x54x1,6	7,5	500	15 + 150	3600x1900x2500	870	5300

# Semi-automatic Bandsaws type XS

Best  
Quality



Control panel



Motorised roller table

The semi-automatic hydraulic straight cut bandsaws type XS embody the best sawing technology and the best performance in the cutting of special steel. Electro-welded structure and steel sawframe meet every cutting needs and eliminates vibration and noise.

## Various features for the semi-automatic bandsaws type XS:

- A distinctive feature of this machine are the rollers for the positioning of the material which are driven by an oleodynamic motor.
- Finely ground TCT blade guides are hydraulically tensioned for maximum precision and squareness of cut.
- The sawblade is tensioned by means of an hydraulic cylinder controlled by the machine software.
- The hydraulic unit is equipped with a variable capacity pump, complete with pressure reducer.
- During the cutting cycle the software compares the blade stress with the pre-selected one. Thanks to this system the sawing machine can stop without problem if there are some considerable changes.
- The moving blade guides are automatically positioned close to the cutting area for maximum precision.
- All the movements are powered via recirculating ballscrews by vector electric motors, the blade is powered by vector motor.
- Motorized chip conveyor hydraulically powered and the speed is adjustable.
- The material is supported by a table with seven rollers powered by hydraulic orbital motor that allows to position the material with precision, even with maximum loads.
- Coolant pump, capacity 220 litres.

Art. no.	Type	Suitable for material	Angular cut	Cutting capacity 90° round/square/rect.	Blade size	Motor blade power	Blade speed	Motor hydraulic unit	Tank cap. hydr. unit	Dimension WxLxH	Height work-table	Weight
				mm	mm	kW	m/min.	kW	litres	mm	mm	kg
31678	XS 900	steel/cast iron/ high-strength steels/alloys	90°	900/900/ 900x900	9300x67x1,6	11	14 ÷ 60	3	80	4485x1680x3150	790	8450
31679	XS 1200	steel/cast iron/ high-strength steels/alloys	90°	1000/1000/ 1200x1000	11300x80x1,6	18	14 ÷ 60	13	40	5000x1680x3150	790	9000

# Transfluid pipe bending machine type MB

Best  
Quality

Made in  
EU  
★★★



## Transfluid mobile pipe bending machines

What makes Transfluid mobile bending machines stand out, is their very good price-to-performance ratio and their simple but effective technology, which offers exceptional engineering capabilities.

Uncompromising compact, versatile and simply excellent machines. Can be used as a simple pipe bending machine or with optional features to install on site. Saw, internal and external deburrs assembly of all related systems (cutting ring pre-assembly, flaring, etc.)

All built-in or attached devices are also available as standalone machines.

- Bending radius 2 - 3,5 / 2 - 3,0x Ø
- Capacity from 6-42mm to 20-125mm
- Bending angle max 150°

*Can be fitted with the following equipment:*

- external and internal deburring
- equipment for pre-assembly of cutting rings (only MB642)
- equipment for flaring of tube ends to 37 ° (only MB642)

Art. No.	Type	Capacity	Bending radius	Max bending angle
		mm Ø	Min/Max mm	°
	MB 642	6-42	2 - 3,0 Ø	150
	MB 2060	6-60	2 - 3,0 Ø	150
	MB 3080	20-80	2 - 3,5 Ø	150
	MB 30115	20-115	2 - 3,5 Ø	150

# Transfluid pipe bending machine type DB / K

Best  
Quality

Made in  
EU  
★★★



- Radii between 1.5-2.5 Ø
- Pipe lengths between 1500 - 6000 mm
- Digital preselection of up to 8 bending angles



Available with:

- Internal and external deburring
- Equipment for pre-assembly of cutting rings

Transfluid Series K mandrel bending machines are especially compact, powerful and reasonably priced bending machines that are controlled fully hydraulically.

Up to 8 bending angles can be preselected digitally (target value), displayed permanently as the actual value and switched off. Additional functions (cutting ring pre-assembly, flaring, de-burring, sawing and chamfering) can be integrated on request.

Art. No.	Type	Max capacity steel	Max capacity stainless	Steel SCH 40	Box section	Bending time 90°
		mm	mm	"	mm	sek.
	DB 642K	42 x 5 mm	42 x 5 mm	1 1/4 "	25 x 3,2 mm	7 sec.
	DB 648K	50 x 4 mm	50 x 3 mm	1 1/2 "	40 x 3 mm	8 sec.
	DB 2060K	76,1 x 3 mm	76,1 x 2 mm	2 1/2 "	50 x 4 mm	8 sec.
	DB 20101K	101,6 x 3,5 mm	101,6 x 2 mm	3 1/2 "	80 x 4 mm	9 sec.

Art No.	Type	 Bending axis A	 Bending axis B	Max. radius	Working length	Enhanced working length
		mm	mm	mm	mm	mm
	DB 642K	35 x 25 x 3,2 mm	25 x 35 x 3,2 mm	85 mm	3048 mm	4572 / 6096 mm
	DB 648K	25 x 50 x 3,0 mm	50 x 25 x 3,0 mm	125 mm	3048 mm	4572 / 6096 mm
	DB 2060K	25 x 60 x 3,5 mm	60 x 25 x 3,5 mm	150 mm	3048 mm	4572 / 6096 mm
	DB 20101K	60 x 80 x 5,0 mm	80 x 60 x 5,0 mm	205 mm	3048 mm	4572 / 6096 mm

# Transfluid pipe bending machine type DB / ST

Best  
Quality

Made in  
EU  
★★★



- Radii between 1.5-2.5 Ø
- Pipe lengths between 3000 - 6000 mm
- Angle presets via touch panel
- Program memory

All machines in this series have a very narrow bending head, offering almost endless bending freedom. Sophisticated technology ensures short bending cycles.

The long-neck collet chuck enables short pipe ends to be bent without subsequent cutting. Machines feature a modular design, enabling you to add on as needed to meet future requirements.

Art. No.	Type	Max capacity steel	Max capacity stainless	Steel SCH 40	Box section	Bending time 90 °
		mm	mm	"	mm	sek.
	DB 622ST	22 X 2,0 mm	22 x 1,5 mm	3/8 "	20 x 1,5 mm	2,3 sec.
	DB 630ST	30 x 2,0 mm	30 x 1,5 mm	3/4 "	25 x 2,5 mm	2,5 sec.
	DB 650ST	50 x 3,0 mm	50 x 2,0 mm	1 1/4 "	35 x 2,5 mm	2,7 sec.
	DB 2076ST	76,1 x 3,0 mm	76,1 x 2,0 mm	2 1/2 "	60 x 2,5 mm	3,3 sec.
	DB 2090ST	88,9 x 5,0 mm	88,9 x 5,0 mm	3 "	75 x 3,0 mm	4,3 sec.

Art No.	Type	Bending axis A	Bending axis B	Max. radius	Working length	Enhanced working length
		mm	mm	mm	mm	mm
	DB 622ST	15 x 20 x 2,0 mm	20 x 15 x 2,0 mm	55 mm	3048 mm	4572 / 6096 mm
	DB 630ST	25 x 30 x 2,5 mm	30 x 25 x 2,5 mm	75 mm	4572 mm	4572 / 6096 mm
	DB 650ST	25 x 40 x 2,0 mm	40 x 25 x 2,0 mm	125 mm	4572 mm	4572 / 6096 mm
	DB 2076ST	40 x 60 x 3,5 mm	60 x 40 x 3,5 mm	190 mm	4572 mm	4572 / 6096 mm
	DB 2090ST	50 x 75 x 4,0 mm	75 x 50 x 4,0 mm	225 mm	4572 mm	4572 / 6096 mm

# Transfluid pipe bending machine type DB / CNC

Best  
Quality

Made in  
EU  
★★★

- Push bending
- Right / left bending
- booster on the center line
- Several different radius tools at once
- Weld seam detection
- Auto. Insertion tube



Automatic mandrel bending machines are impressive thanks to their stability and extreme bending freedom. They have maintenance-free energy-saving drive systems with powerful hydraulic or electric bending.

State-of-the-art software and electronics enable countless connection options. All custom equipment requirements, such as multiple levels for free-form functions or the like, can be implemented

Art. No.	Type	Max capacity steel	Max capacity stainless	Steel SCH 40	Box section
		mm	mm	"	mm
	DB 622-CNC	22 X 1,5 mm	22 x 1,5 mm	3/8 "	16 x 1,5 mm
	DB 630-CNC	30 x 2,0 mm	30 x 1,5 mm	3/4 "	20 x 2,5 mm
	DB 642-CNC	42 x 4,0 mm	42 x 3,0 mm	1 1/4 "	25 x 2,5 mm
	DB 2060-CNC	60,3 x 5,0 mm	60,3 x 3,0 mm	2 "	40 x 3,0 mm
	DB 2090-CNC	88,9 x 3,0 mm	88,9 x 2,0 mm	3 " sch 10	50 x 2,5 mm

Art. No.	Type	Bending time	Max. radius	Working length	Enhanced working length
		° / sek.	mm	mm	mm
	DB 622-CNC	135 ° / sec.	55 mm	3048 mm	4572 / 6096 mm
	DB 630-CNC	125 ° / sec.	85 mm	3048 mm	4572 / 6096 mm
	DB 642-CNC	75 ° / sec.	105 mm	3048 mm	4572 / 6096 mm
	DB 2060-CNC	65 ° / sec.	150 mm	3048 mm	4572 / 6096 mm
	DB 2090-CNC	50 ° / sec.	225 mm	3048 mm	4572 / 6096 mm

# Transfluid pipe bending machine type 3A-CNC

Best  
Quality

Made in  
EU  
★★★

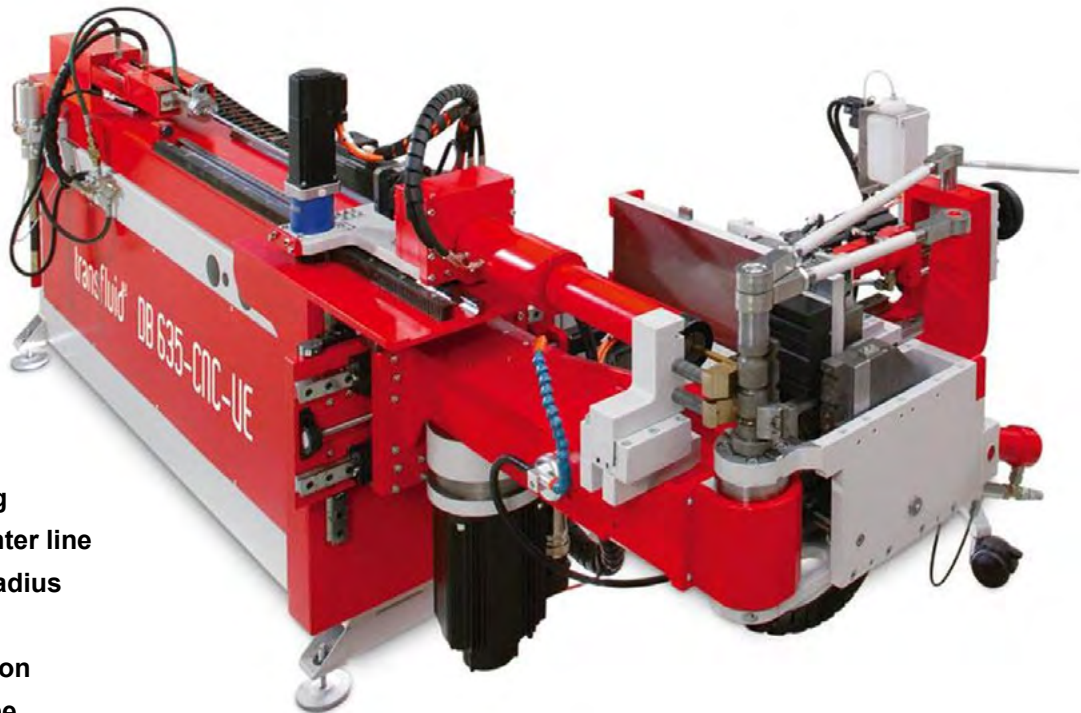

- Large diameters
- Push bending
- Right / left bending
- booster on the center line
- Several different radius tools at once
- Weld seam detection
- Auto. Insertion tube

This series of bending machines enables bending dimensions up to a maximum diameter of 273 mm or 10,75" OD. The machine can handle small bending radii and the slightest of weaknesses in wall thickness with ease.

The solid construction ensures an especially long service life, while fast tool changes increase productivity and flexibility. All machines come with a powerful automatic CNC controller.

Art. No.	Type	Max capacity steel	Max capacity stainless	Steel SCH 40 / 80
		mm	mm	"
	DB 40139-3A-CNC	140 X 6,0 mm	140 x 4,0 mm	5 " / 4 1/2"
	DB 40168-3A-CNC	170 x 8,0 mm	170 x 6,0 mm	6 " / 5 "
	DB 40220-3A-CNC	220 x 10,0 mm	220 x 10,0 mm	8 " / 7 "

Art. No.	Type	Bending time	Max radius	Working length
		° / sek.	mm	mm
	DB 40139-3A-CNC	10 ° / sec.	350 mm	6096 mm
	DB 40168-3A-CNC	7 ° / sec.	425 mm	6096 mm
	DB 40220-3A-CNC	6 ° / sec.	700 mm	6096 mm

# Transfluid expanders

Best  
Quality



EX 3076-HA

Transfluid expanders

Transfluid EX are machines for end forming (expanding, reduction and shearing). Especially useful for exhaust systems.

Available with one head or more, depending on the task.

Art. No.	Type	Capacity steel	Max. wall thickness	Nominal pressure	Work pressure	Process time
		mm Ø	mm	bar	bar	sek.
	EX 3076-HA	30 - 76 mm	3 mm	250 bar	200 bar	11 sek.



# Transfluid pipe forming machines

Best  
Quality

Made in  
EU  
★★★



UMR 628 HA



UMR 30115 HA

This machine series is perfect for manufacturing highly complex forming shapes. Forms with extremely tight tolerances and polished surfaces can be created.

All set motions are especially powerful and are monitored electronically. The highest level of sophisticated patented technology.

Tool changes are fast and easy, allowing these machines to form from outside to inside and cut pipes as well as carry out the same steps from inside to outside.

Series UMR machines are also ideal for producing all types of flares at pipe ends. With a minimum clamp length of  $0.5 \times D$ , almost any type of flare can be created in exceptional quality.

Art. No.	Type	Capacity steel	Max wall thickness	RPM	Process time
		mm Ø	mm		sek.
	UMR 628 HA	06 - 28 mm	2,5 mm	603	4 - 8 sec
	UMR 642 HO	06 - 42 mm	4,0 mm	200	4 - 10 sec
	UMR 665 HA	06 - 65 mm	5,0 mm	95	6 - 12 sec
	UMR 30115 HA	30 - 115 mm	4,0 mm	70	8 - 20 sec

# Transfluid pipe forming machines

Best  
Quality

Made in  
EU  
★★★



- Complex geometries
- Up to 8 tools

Transfluid end processing machines type REB is precise, fast and universal. They can create unimaginable variety of forms with complex geometries and very fast tool changes. Can have up to 8 tools controlled by a touch screen.

These machines are most often used when Special geometries are required in mass production.

The tubes are shaped by these machines in sequences of up to 6 times.

Tool change during this process is carried horizontally or vertically with servo systems.

A special clamping device also complex and extreme degrees of axial tube forming.

Art. No.	Type	Capacity steel	Forming power	Clamping power	Additional clamping
		mm	kN	kN	kN
	REB 420	3 - 20 mm	64 kN	64 kN	39 kN
	REB 632	6 - 32 mm	98 kN	98 kN	64 kN
	REB 645	6 - 45 mm	147 kN	147 kN	98 kN
	REB 660	6 - 60 mm	240 kN	240 kN	147 kN

Art. No.	Type	Forming length	Cycle time	Cycle time additional forming	Cycle time clamping
		mm	sek.	sek.	sek.
	REB 420	60 mm	3,0 sek.	2,0 sek.	3,0 sek.
	REB 632	80 mm	4,0 sek.	3,0 sek.	3,0 sek.
	REB 645	90 mm	6,0 sek.	4,0 sek.	4,0 sek.
	REB 660	100 mm	9,0 sek.	5,0 sek.	5,0 sek.

# Transfluid chipless cutting machines

Best  
Quality

Made in  
EU  
★ ★ ★



RTO 628

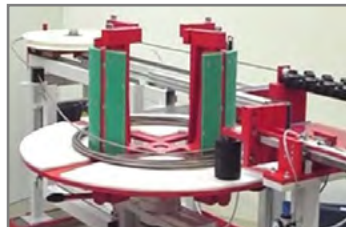

Both chipless orbital cutting machines and the scarfing knife cutting process, ideal for accurate trimming, provide for low-bur cuts. With both of these stages it is thus possible to further process the pipes directly after cutting.

In chipless orbital pipe cutting, the pipes are placed under a pulling process during the cutting operation with varying torques that depend on the tube sizes. This prevents the cutting position from collapsing and allows forming to begin directly. Pipe cutting machines from transfluid® offer cutting rates of 1,800 pieces per hour and optimize the cut length in order to minimize residual lengths. The pipes can be fed automatically through suitable straightening systems into the pipe cutting machine and then ejected after the pipe cutting.

The scarfing knife cutting process dependably shears pipes of all materials with right angles and sharp edges even when working with very awkward pipe geometries. Cuts in different degrees are also possible if required. In addition to this, up to three knives and an internal mandrel can be used for high-precision pipe cutting when required.

Art. No.	Type	Capacity steel	Cutting length	Max wall thickness	Nominal pressure	Work pressure	Cycle time
		mm Ø	mm	mm	bar	bar	sec.
	RTO 628	06 - 28 mm	55 / 25 mm	2 mm	200 bar	200 bar	2 - 8 sec.

# Transfluid special machines

Best  
Quality

various options with robot

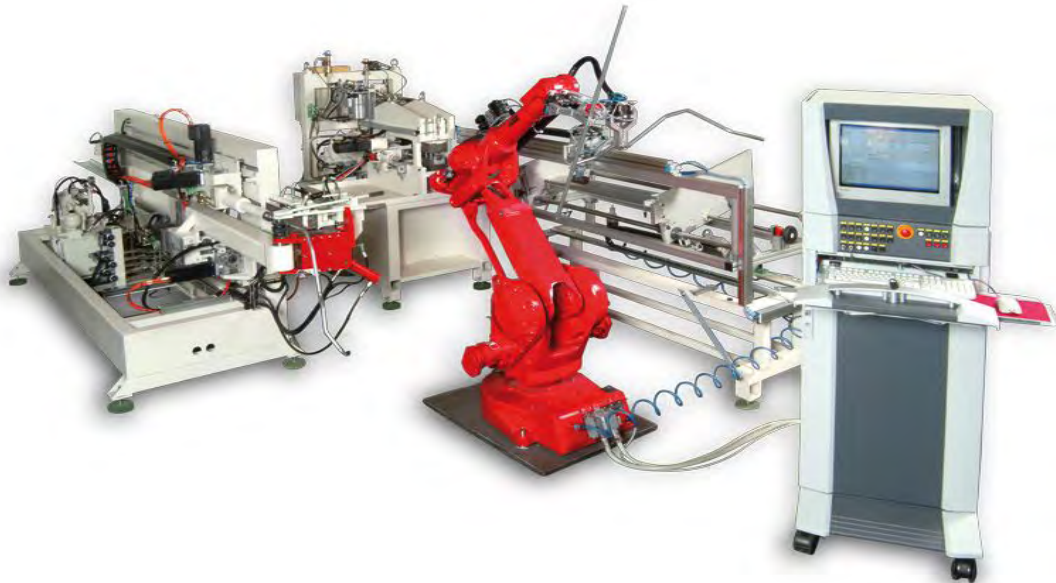

Complete centers with automatic loader, end processing, bends and unloader.



# Jutec pipe bending machine type KBV

Best  
Quality

Made in  
EU



The compact, mobile type of construction enables precise and repeatable bending in the bench vice. The device is driven by means of a screw-in handle. A lockable set collar ensures repeatable bending. The exchange of pluggable tools is as easy as can be. The principle "stationary tube and rotating tool" enables bending requiring smallest possible space. For thin-walled tubes slide shoes are used for wrinkle-free bending in order to produce arcs, for example from tubes made of stainless steel and copper, with smallest possible deformations. The optional type of construction with hexagonal holding fixture enables, besides utilization in the bench vice, also using the driving forces of the bending systems 3000 and 6000. For this purpose the KBV is simply mounted onto the bending shaft of the machine.

Art. No.	Type	Capacity	Max Bending angle
		mm Ø	°
16600	KBV	6-18	180
16602	KBVS	6-18	180

# Jutec pipe bending machine type 3000

Best  
Quality

Made in  
EU  
★★★



The compact, mobile type of construction enables precise and repeatable bending both stationary and directly at site or at the place of mounting, respectively. A strong motor and a precision gear cater for powerful drive. By means of position detection directly on the bending axis, optimum bending accuracy is achieved. The bending angle is easily and quickly set via set/actual value display. For transport purposes, the compact unit can be neatly and safely stored in solid transport cases. At the mounting place, the tripod and the principle "stationary tube and rotating tool" enable bending with lowest possible space requirements. For thin-walled tubes slide shoes are used for wrinkle-free bending in order to produce arcs, for example from tubes made of stainless steel and copper, with smallest possible deformations. With the profile bending adaptor PB 20, flat steel bars, square steel and round bars can be bent without problems.

- |  |  |
|--|--|
| <ul style="list-style-type: none"> <li>• Bending capacity Ø 6 to 35 mm, CU Ø 42 mm</li> <li>• Bending radius min/max: 36mm/150mm</li> <li>• Precise digital setting of bending angle</li> <li>• Bending result max 180°</li> </ul> | <ul style="list-style-type: none"> <li>• Hexagonal shaft 40mm for quick tool change</li> <li>• Safety pedal switch with emergency stop function</li> <li>• Alternative current 230 V connection</li> </ul> |
|--|--|

Art. No.	Type	Capacity	Bending radius	Max bending angle	Weight
		mm Ø	Min/Max mm	°	Kg
16605	3000	6-36	36/110	180	21

# Jutec pipe bending machine type 6000 S / D

Best  
Quality

Made in  
EU  
★★★



The compact, mobile type of construction enables precise and repeatable bending up to an outer diameter of 60mm both stationary and at the place of mounting. A strong three-phase motor and a precision gear cater for powerful drive. By means of position recording directly on the bending axis we achieve optimum bending accuracy. The bending angle is easily and quickly set via a comfortable and menu-driven user interface with touchscreen control, which guarantees an even more intuitive operation. For more complex bending tasks, bending programs can be stored, which provide a succession of angles of 8 bends max. per geometry. By the multi-function control, the bending speed for the forward and reverse can be set variable and there is configurable overbend function to compensate for material springback. At the end of the bow, the tool returns automatically, whereby the bending process is significantly shorter. Four transport rollers (decelerated) together with a trapezoidal enlargement cater for stable positioning and save machine travel. The principle "stationary tube and rotating tool" enables bending with lowest possible space requirements. For thin-walled tubes slide shoes are used for wrinkle-free bending and in order to produce bends, for example from tubes made of stainless steel and copper, with smallest possible deformations. With the profile bending adaptor PB20, flat steel bars, square steel and round bars can be bent without problems.

- |   |   |
|---|---|
| <ul style="list-style-type: none"> <li>• Capacity 6000S: Ø10 to 50x5 mm, alternative current 230V</li> <li>• Capacity 6000D: Ø10 to 60x5 mm, three-phase 400V</li> <li>• Bending radius min/max: 36mm/250mm</li> <li>• Optional: large bending radii up to 500 mm</li> <li>• Touchscreen</li> </ul> | <ul style="list-style-type: none"> <li>• Multi functional machine control</li> <li>• Digital setting of bending angle (0,1°)</li> <li>• Bending result 180° max.</li> <li>• Hexagonal shaft 40mm for quick tool change</li> <li>• Safety pedal switch with emergency stop function</li> </ul> |
|---|---|

Art. No.	Type	Capacity	Bending radius	Max bending angle	Weight
		mm Ø	Min/Max mm	°	Kg
16620	6000S	10-50	36/250	180	110
16622	6000D	10-60	36/250	180	110
16624	6000DS	10-60	36/250	180	110
16626	6000DL	10-60	36/250	180	110

# Jutec pipe bending machine type 4800

Best  
Quality

Made in  
EU

★ ★ ★



This mandrel bending system with eccentric rapid chucking for tube fixing enables low-cost bending. The compact drive unit with detachable mandrel support offers advantages when used at the place of installation. By means of a position recording directly on the bending axis we achieve optimum bending accuracy. Setting of the bending angle is made easily and quickly via digital nominal/actual value display. For more complex bending tasks bending programs can be stored, disposing of an angle sequence of 9 bends max. per geometry. 60 individual angles and 40 bending angle sequences (programs) can be stored. Pluggable bending tools enable quick retrofitting for other tube dimensions. For difficult geometries, the bending direction of the machine can be retrofitted to right-hand or left-hand bending as a standard. The open bending unit allows, for example, bending of handrail frames with one welding seam only. The optional calculation software on the PC determines the cut length for the total geometry as well as traverse path, torsion angle and bending angle for every bend. Mandrel retraction can be programmed and the mandrel can be automatically retracted ahead of schedule when a certain bending angle has been accomplished.



- |   |   |
|---|---|
| <ul style="list-style-type: none"> <li>• Bending performance Ø 6 to 50mm</li> <li>• Bending radius min/max: 10mm/140mm</li> <li>• Bending radii standard 2 x Ø</li> <li>• Multi functional machine control</li> </ul> | <ul style="list-style-type: none"> <li>• Digital setting of bending angle (0.1°)</li> <li>• Mandrel support 1500, 3000, 4500 &amp; 6000mm</li> <li>• Pedal with emergency stop</li> <li>• Weight 600-700kg</li> </ul> |
|---|---|

Art. No.	Type	Capacity	Bending radius	Max bending angle	Mandrel support	Weight
		mm Ø	Min/Max mm	°	mm	Kg
16635	4815	6-50	10/250	180	1500	600
16636	4830	6-50	10/250	180	3000	630
16637	4845	6-50	10/250	180	4500	650
16638	4860	6-50	10/250	180	6000	700



# Jutec pipe bending machine type 5000

Best  
Quality

Made in  
EU  
★★★



JUTEC mandrel bending machine model 5000 – the cost-effective bending machine for narrow bending radii. The compact drive unit with detachable mandrel holder offers advantages when used at the place of installation. The free-standing bending head can easily be modified to left-hand bending and right-hand bending for difficult geometries. The pluggable bending tools enable quick retrofitting for bending other tube dimensions. A fast hydraulic system for reducing bending times is an important factor for series production. The locking clamp pressure for tube clamping can be optimally adjusted. The SPS control with data storage and CAN bus interface can store approx. 200 programs for bending angle, linear measure and torsion angle for a maximum of 30 bending sequences at one tube length. A database containing any number of materials is available for monitoring the elastic recovery values. The machine disposes of two operational modes: In “simple bending” length and torsion of the arcs towards each other are automatically displayed. In the mode “controlled bending” the data is stored beforehand and a permanent nominal/actual comparison is made during bending. This way, false positioning within a tolerance window is excluded and thus the user-related error rate is minimised. General error messages are shown on the big screen with full text. Mandrel retraction can be programmed and the mandrel can be retracted ahead of schedule when a certain bending angle has been accomplished.

- |   |   |
|---|---|
| <ul style="list-style-type: none"> <li>• Bending performance Ø 6 to 50mm</li> <li>• Bending radius min/max: 10mm/250mm</li> <li>• Bending radii standard 1.5 x Ø (standard 2 x Ø)</li> <li>• Multi functional machine control</li> <li>• Digital setting of bending angle (0.1°)</li> </ul> | <ul style="list-style-type: none"> <li>• Mandrel support 1500, 3000, 4500 &amp; 6000mm</li> <li>• Pedal with emergency stop</li> <li>• AC 400V</li> <li>• Weight 600-700kg</li> </ul> |
|---|---|

Art. No	Type	Capacity	Bending radius	Max bending angle	Mandrel support	Weight
		mm Ø	Min/Max mm	°	mm	Kg
16639	5015	6-50	10/250	180	1500	600
16640	5030	6-50	10/250	180	3000	630
16641	5045	6-50	10/250	180	4500	650
16642	5060	6-50	10/250	180	6000	700

# Jutec pipe bending machine type 7000-9000

Best  
Quality

Made in  
EU  
★★★



For tube dimensions of 20mm to 88.9mm this bending system offers solutions for complex geometries with standard radii of 2xD. Depending on material quality and wall thickness ratio also radii of 1.5xD can be realised suitable for series production. At a tool height of 120mm there are also sufficient possibilities for special profiles. The extremely precise and strong drive of the bending axis and the stable and rigid construction of the mandrel support and the bending arm contribute also to the desired bending result. The pluggable bending tools enable quick retrofitting for bending other tube dimensions. The locking clamp pressure for tube clamping can be optimally adjusted. The SPS control with data storage and latest X2X interface can store 500 programs (can be expanded via USB plug) for bending angle, linear measure and torsion angle for a maximum of 50 bending sequences at one tube length. A freely programmable database for any number of materials (USB) is available for monitoring the elastic recovery values. The machine disposes of two operational modes: In "simple bending" length and torsion of the bends towards each other are automatically displayed. In the mode "controlled bending" the data is stored beforehand and a permanent nominal/ actual comparison is made during bending.

On request all bending systems are also available with pneumatic rotation stop.

## Capacity 7000:

Ø20-Ø70mm. Radii standard 2 X Ø  
Radii minimum 1,5 X Ø (Optional)

## Capacity 9000:

Ø20-Ø90mm. Radii standard 2 X Ø  
Radii minimum 1,5 X Ø (Optional)

Art. No.	Type	Capacity	Bending radius	Max bending angle	Mandrel support	Weight
		mm Ø	Min/Max mm	°	mm	Kg
16643	7030	20-70	40/250	180	3000	2000-3000
16644	7045	20-70	40/250	180	4500	2000-3000
16645	7060	20-70	40/250	180	6000	2000-3000
16646	9030	20-90	40/250	180	3000	2000-3000
16647	9045	20-90	40/250	180	4500	2000-3000
16648	9060	20-90	40/250	180	6000	2000-3000

# Drilling machines type Kap 25

Best  
Quality

Made in  
EU  
★★★



Drilling machine type Kap 25 is a perfect mix of price and quality. The machine is using helical gears in steel in combination with fibergear wheels, which ensures a quiet and powerful transmission. Drilling head and table can be adjusted 360° around the column and be raised / lowered as needed. The machine is equipped with thermal overload protection. Worktable is equipped with T-slots.

Type Kap 25 is also offered as a bench drilling machine. Both models with manual feed.

## Accessories

- Tool package MT 3
- Manual reversing
- Coolant complete with tubes
- Machine light Halogen, 24 V

Art. No.	Type	Drilling capacity	Spindle stroke	Tapping capacity	Spindle taper	Speed range	Table dimensions	Motor	Weight
		mm	mm			o/m	mm	kw	kg
17235	Kap 25	25	135	M16	MK3	105-2900	500x350	0,9	195
17236	Kap 25 B	25	135	M16	MK3	105-2900	500x350	0,9	150

# Drilling machines type A2608

Best  
Quality

Made in  
EU



A 2608



A 2608B



A 2608M

**ARBOGA A2608** has a drilling capacity of 25mm. The gearbox is built according to our experienced methods for highest possible torque. Helical gears combined with steel gears against reinforced fibre gears in the main gear box ensure higher operation efficiency, a more powerful drive mechanism and smooth operation. Both the drill head and the table arm are adjustable 360° around the column and can be raised and lowered.

**ARBOGA A2608M:** When the set drill depth is reached, the spindle will automatically return to the starting point. The feed gear box is provided with an automatic overload protection device, which intervenes when the drill pressure is too high. The feed can also be interrupted manually. Chuck guard with micro switch is standard for machines within CE area. Is also available as bench drilling machine.

## Accessories

- Tool package MT 3
- Automatic reversing unit for tapping, type ( M ) only
- Coolant complete with tubes
- Hand reversing switch
- Machine light Halogen, 24 V
- Connection cable. 5 m. with 16 A CE
- Microswitch for chuckguard
- Foot operated start / stop switch
- Machined baseplate
- DRO for depth stop
- Threaded spindle nose w. locking nut
- Coordinate table type FB 102.
- Milling chuck MT 3; 6, 8, 10, 12, 16 mm
- Drill chuck with arbor 0 - 13 mm, MT 3
- Drill chuck with arbor 3 - 16 mm, MT 3
- Special paint

Art. No	Type	Drilling capacity	Spindle stroke	Tapping capacity	Spindle taper	Number of speeds	Speed range	Distance spindle / column	Table dimensions	Motor	Weight
		mm	mm				o/m	mm	mm	kw	kg
17100	2608	25	135	M16 / M20	MT3	8	105-2900	255	500x400	0,9	200
17101	2608 B	25	135	M16 / M20	MT3	8	105-2900	255	500x400	0,9	
17102	2608 T	25	135	M16 / M20	MT3	8	105-2900	255	500x400	0,9	200
17103	2608 M	25	135	M16 / M20	MT3	8	105-2900	255	500x400	0,9	200
17104	2608 BM	25	135	M16 / M20	MT3	8	105-2900	255	500x400	0,9	200

# Drilling machines type A3008

Best  
Quality

Made in  
EU



A 3008



A 3008B



A 3008M

**ARBOGA A3008** has a drilling capacity of 30mm. Helical gears combined with steel gears against reinforced fibre gears in the main gear box ensures higher operation efficiency, a powerful drive mechanism and smooth operation. A 3008 is standard-equipped with a handreversing switch. Both the drill head and the table arm are adjustable 360° around the column and can be raised and lowered.

**ARBOGA A3008M:** When the set drill depth is reached, the spindle will automatically return to the starting point. The feed gear box is provided with an automatic overload protection device, which intervenes, when the drill pressure is too high. The feed can also be interrupted manually.

Chuck guard with micro switch is standard for machines within CE area.

Is also available as bench drilling machine.

## Accessories

- Tool package MT 3
- Automatic reversing unit for tapping
- Coolant complete with tubes
- Machine light Halogen, 24 V
- Connection cable. 5 m. with 16 A CE
- Microswitch for chuckguard
- Foot operated reversing switch
- Foot operated start / stop switch
- Threaded spindle nose w. locking nut
- Coordinate table type FB 102.
- Milling chuck MT 3; 6, 8, 10, 12, 16 mm
- Drill chuck with arbor 0 - 13 mm, MT 3
- Drill chuck with arbor 3 - 16 mm, MT 3
- Special paint

Art. No	Type	Drilling capacity	Spindle stroke	Tapping capacity	Spindle taper	Number of speeds	Speed range	Distance spindle / column	Table dimensions	Motor	Weight
		mm	mm				o/m	mm	mm	kw	kg
17130	3008	30	150	M18 / M22	MT3	8	75-3010	320	500x400	1,2	260
17131	3008 M	30	150	M18 / M22	MT3	8	75-3010	320	500x400	1,2	260
17132	3008 B	30	150	M18 / M22	MT3	8	75-3010	320	500x400	1,2	
17133	3008 BM	30	150	M18 / M22	MT3	8	75-3010	320	500x400	1,2	260

# Drilling machines type A3008 FLEX(M)

Best  
Quality

Made in  
EU  
★★★

Stepless speed



A 3008 FLEX



A 3008 FLEX M

**ARBOGA A3008 FLEX and FLEX M** has a drilling capacity of 30 mm. Helical gears combined with steel gears against reinforced fibre gears in the main gear box ensures higher operation efficiency, a powerful drive mechanism and smooth operation. Both the drill head and the table arm are adjustable 360° around the column and can be raised and lowered.

**Type A3008 FLEX and FLEX M** are with stepless speed control designed according to the newest technology in order to achieve the best possible torque. Speed range 50-3800 o./min. High/low gear. Automatic reversing of spindle motor is standard. Type FLEX M with automatic feed.

## Accessories

- Tool package MT 3
- Rectangular table 600x500 mm
- Coolant complete with tubes
- Machine light Halogen, 24 V
- Spindle w. flange for or drilling head w. several spindles
- Connection cable. 5 m. with 16 A CE
- Foot operated reversing switch
- Foot operated start/stop switch
- Threaded spindle nose w. locking nut
- Coordinate table type FB 102.
- Milling chuck ER MT 3; 6, 8, 10, 12 and 16 mm
- Drill chuck with arbor 0 - 13 mm, MT 3
- Drill chuck with arbor 3 - 16 mm, MT 3
- Special paint

Art. No	Type	Drilling capacity	Spindle stroke	Tapping capacity	Spindle taper	Speed range	Distance spindle / column	Table dimensions	Motor	Weight
		mm	mm			stepless	mm	mm	kW	kg
17250	A3008 FLEX	30	150	M18 / M22	MK3	50-3800	320	500x400	1,2	256
17251	A3008 FLEX M	30	150	M18 / M22	MK3	50-3800	320	500x400	1,2	263

# Drilling machines type A3808

Best  
Quality

Made in  
EU



A 3808M

**ARBOGA A3808** has a drilling capacity of 35mm. The gear box is built according to our experienced methods for highest possible torque. Both the drill head and the table arm are adjustable 360° around the column and can be raised and lowered. A 3808 is standard-equipped with a hand-reversing switch.

**ARBOGA A3808M:** When the set drill depth is reached, the spindle will automatically return to the starting point. The feed can also be interrupted manually. The feed gear box is provided with an automatic overload protection device, which intervenes, when the drill pressure is too high.

**ARBOGA A3808ELM:** Start/Stop of the automatic feed is handled by buttons at the top of the feed lever. Hand and automatic reversing for tapping are standard.

Chuck guard with micro switch is standard for machines within CE area

## Accessories

- Tool package MT 4
- Automatic reversing unit for tapping, type ( M ) only
- Coolant complete with tubes
- Machine light Halogen, 24 V
- Connection cable. 5 m. with 16 A CE
- Microswitch for chuckguard
- Foot operated reversing switch
- Foot operated start / stop switch
- Threaded spindle nose w. locking nut
- Flanged quill for multi spindle drill head
- Coordinate table type FB 102.
- Milling chuck MT 4; 6, 8, 10, 12, 20 mm
- Drill chuck with arbor 0 - 13 mm, MT 4
- Drill chuck with arbor 3 - 16 mm, MT 4
- Special paint

Art. No	Type	Drilling capacity	Spindle stroke	Tapping capacity	Spindle taper	Number of speeds	Speed range	Distance spindle / column	Table dimensions	Motor	Weight
		mm	mm				o/m	mm	mm	kw	kg
17160	3808	35	150	M18 / M22	MT4	8	75-3010	320	500x400	2	290
17161	3808 M	35	150	M18 / M22	MT4	8	75-3010	320	500x400	2	290
17162	3808 ELM	35	150	M18 / M22	MT4	8	75-3010	320	500x400	2	290

# Drilling machines type A4008

Best  
Quality

Made in  
EU  
★★★



**ARBOGA A4008** has a drilling capacity of 40mm. The gear box is built according to our experienced methods for highest possible torque. The drill head is fixed on top of the column. The table arm is adjustable 360° around the column and can be raised and lowered.

**ARBOGA A4008M:** When the set drill depth is reached, the spindle will automatically return to the starting point. The feed can also be interrupted manually. The feed gear box is provided with an automatic overload protection device, which intervenes, when the drill pressure is too high.

**ARBOGA A4008ELM:** Start / Stop of the automatic feed are handled by buttons at the top of the feed lever. Hand and automatic reversing for tapping are standard.

Chuck guard with micro switch is standard for machines within CE area.

## Accessories

- Tool package MT 4
- Automatic reversing unit for tapping
- Coolant complete with tubes
- Machine light Halogen, 24 V
- Microswitch for chuckguard
- Rectangular table 600 x 500 mm
- Rotary device for table 400 x 500 mm
- Foot operated start / stop switch
- Threaded spindle nose w. locking nut
- Low spindle speeds, 60 - 980 rpm
- High spindle speeds, 180 - 3000 rpm
- 3-spoke handle
- Milling table FB 102 ( instead of standard table )
- Milling chuck ER MT 4; 6, 8, 10, 12, 20 mm

Art. No	Type	Drilling capacity	Spindle stroke	Tapping capacity	Spindle taper	Number of speeds	Speed range	Distance spindle / column	Table dimensions	Motor	Weight
		mm	mm				o/m	mm	mm	kw	kg
17190	4008	40	190	M24 / M28	MT4	8	90-1500	330	500x400	2,6	320
17191	4008 M	40	190	M24 / M28	MT4	8	90-1500	330	500x400	2,6	320
17192	4008 ELM	40	190	M24 / M28	MT4	8	90-1500	330	500x400	2,6	320



# Uni. Drilling/milling machine type A2508U

Best  
Quality

Made in  
EU



A 2508U

**ARBOGA A2508U** is a 25 mm universal milling- / drilling machine. The gearbox is built according to our experienced methods for highest possible torque.

The machine is equipped with a coordinate table with 3 T-slots and coolant channel. Special option: automatic longitudinal feed. There is a wheel on the front of the drill for fine feed. The fine feed ensures a smooth and accurate setting of the cutting depth during milling. When milling, the quill can be locked in the desired position. The machine is suitable for drilling, broaching, tapping and milling. The drill head can be raised and lowered and turned 0-45° vertically to either side. The angular position can be adjusted towards a graduated scale.

Chuck guard with micro switch is standard for machines within CE area.

## Accessories

- Tool package MT 3
- Automatic longitudinal feed FB 102
- Coolant complete with tubes
- Machine light Halogen, 24 V
- Foot operated reversing switch
- Milling chuck MT 3; 6, 8, 10, 12, 16 mm

Art. No	Type	Drilling capacity	Spindle stroke	Tapping capacity	Spindle taper	Number of speeds	Speed range	Distance spindle / column	Table dimensions	Motor	Weight
		mm	mm				o/m	mm	mm	kw	kg
17220	2508U	25	135	M16 / M20	MT3	8	105-2900	258	582x242	0,9	270



# Kapema



**Peter Mortensen**  
Adm. Direktør  
Telefon: +45 9618 8700  
Mobil: +45 4038 1890  
e-mail: pm@kapema.dk



**Kristian Mortensen**  
Direktør  
Telefon: +45 9618 8705  
Mobil: +45 2448 8215  
e-mail: ksm@kapema.dk



**Mogens Sørensen**  
Salgschef  
Telefon: +45 9618 8700  
Mobil: +45 4024 1518  
e-mail: ms@kapema.dk



**Gert Thomsen**  
Produktchef  
Telefon: +45 9618 8700  
Mobil: +45 3030 3820  
e-mail: gt@kapema.dk



**Jette Holm**  
Controller  
Telefon: +45 9618 8704  
e-mail: jh@kapema.dk



**Søs Nielsen**  
Marketingchef  
Telefon: +45 9618 8702  
e-mail: sl@kapema.dk



**Poul Jensen**  
Servicetekniker  
Telefon: +45 9618 8706  
Mobil: +45 4140 6085  
e-mail: pj@kapema.dk



**Torben Andersen**  
Tekniker  
Telefon: +45 9618 8700



**Kirsten M. Badstue**  
Bogholder  
Telefon: +45 9618 8700  
e-mail: bk@kapema.dk

---

**Kapema A/S · Vilhelmsborgvej 16A · DK-7700 Thisted**  
**Tel: +45 9618 8700 · Email: [info@kapema.dk](mailto:info@kapema.dk) · [www.kapema.dk](http://www.kapema.dk)**